

Section 3

BT 1984-on

& XL 1986-on

Badlands.....	42-43
Bulbs.....	12-14
Fender Lights	20
Head Lights.....	2-10
Indicator Lamps.....	11
License Plate Frames.....	36-40
Marker Lights.....	54-60
Modules	42-44
Seal Beams.....	4,9,13-14
Spotlamps.....	15-16
Tail Lights.....	21-35
Turn Signals.....	41-53
Visor.....	11,16-19

Headlight



90407



90419

FLST Chrome Cowl Assembly

Fits 1986-02 FLST, FLSTF. Includes lamp and riser cover. Order hardware separately.

PCP Description

- 90407** T/L Cowl assembly (67907-96C)
- 90408** VT, as above
- 16315** Hardware (67897-96B) required when mounting spotlamps and windshields
- 66141** Upper chrome fork cover set (45963-97)
- 66140** Handlebar top cover (67866-94)

Chrome Head Lamp Housing Kit

Use this kit to update to a Road King style on 1986-on FLT models. Kit for left and right sides includes housing assembly, handlebar top cover, headlamp assembly, top and rear trim strip and mounting hardware. Complete assembly also includes chrome upper fork leg covers and fork air baffle.

PCP Description

- 90419** Housing kit
- 90422** Complete assembly



16315



90416



Chrome 7" Headlight Cowl Kit

Kit includes chrome ABS headlight housing, 7" H-4 lamp assembly with rim, upper fork covers and chrome fork air baffle. Fork covers can be installed without disassembly of forks. Fits 1980-86 FLT and 1983-85 FLHT-FLHTC.

PCP Application

- 90416** 1980-86 FLT, 1983-85 FLHT
- 90417** 1987-92 FLHS

Chrome Head Lamp Housing Assembly

Fits FLT 1986-on to update to the Road King style. Includes right and left side and headlamp assembly with rim.

PCP Description

- 90419** Complete housing assembly with lamp (shown)
- 90409** Housing set only 2003-on (67682-03A, 67674-03A)
- 66140** Handlebar top cover (67866-94)
- 21658** Handlebar top cover
- 62801** Headlamp assembly only 1981-02 (67702-81A)
- 62806** T/L as above w/halogen
- 66141** Chrome slider fork cover set 1980-on (45963-97)
- 66142** Spot lamp bracket (68712-94A)
- 66143** T/L top trim strip (67868-94)
- 21022** Preston top trim strip (67868-94)
- 66144** Rear trim strips (pair) (11489)
- 44402** Adapter kit to attach chrome visor (67761-96)

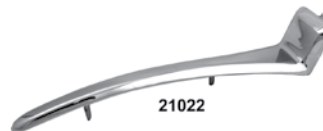

21022

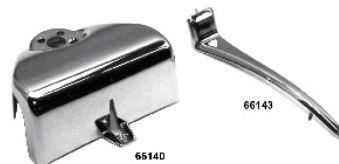

66140



62801

Headlights

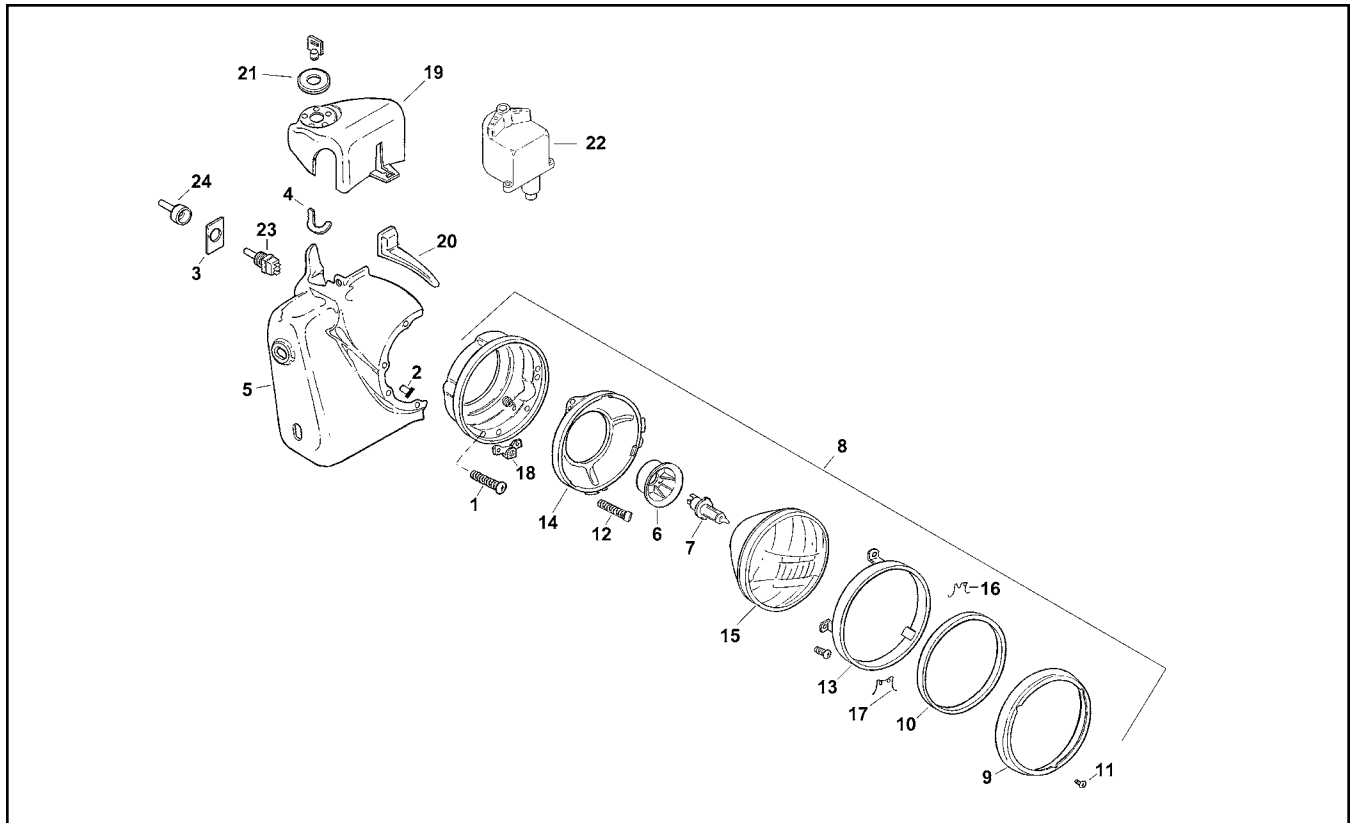

FLHR Headlamp and Chrome Nacelle 1999-on

#	PCP	OEM	Description	#	PCP	OEM	Description
1	24515	922	Screw, headlamp pot to 2004 (10)	14	28432	67732-71	Mounting ring
2	23032	5210	Wellnut (10 pk)	15	56127	67755-81A	Seal beam housing only 1981-02
3	78100	14019-83	On-Off label (each)	16	13004	67778-60	Top retaining spring 1960-02 (10)
4	66144	11489	Rubber trim (2 pc)		13006	67720-03	Top spring 2003-on
5	29806	67674-94	Nacelle, right 1994-02	17	13005	67780-60	Bottom retaining spring to '02 (10)
	29808	67674-03A	Nacelle, right 2003-on	18	78101	67782-60A	Retainer screw bracket 1960-04
	29809	67682-03A	Nacelle, left 2003-on	19	66140	67866-94	Handlebar cover 1994-02
	90409		Nacelle set (left and right) 2003-on		66152	67866-03	Handlebar cover 2003-07
6	23084	67696-81	Boot, bulb 1981-04	20	66143	67868-94	Trim, nacelle top 1994-02
7	17004	67697-81	H-4 Halogen bulb 1981-02		66153	67868-03	Trim, nacelle 2003-07
	17017	68329-03	Halogen bulb 2003-on	21	78102	71310-94	Trim, fork lock
8	62801	67702-81A	Complete headlight assem. 81-02	22	29505	71540-94A	Fork lock
9	28426	67712-83	Door, chrome stock 1983-on	23	78103	71522-96	Switch, lamp/accessory 1996-07
10	23013	67716-60A	Gasket, h/lamp door 1960-02 (ea)	24	78104	74408-89	Boot 1989-07 (ea)
11	24521	67718-60A	Screw, headlamp door (10 pk)				
12	24562	67724-71	Head lamp adjusting screw (5 pk)				
13	28431	67726-71	Seal beam inner retaining ring				



Well Nuts

PCP	OEM	Thread	Type
23032	5210	6/32	Headlight FLT, FLHR (10 pk)
23033	5207	10/32	FXST Module (10 pk)
23015	8099	1/4-20	FXR (10 pk)



Headlight Housing, Light not included

PCP	Description
56344	Chromed ABS FLHS 1987-92, FLHT 1983-85
56349	As above with hole (67680-91)

Headlights



Dual Bulb Halogen Headlamp Kit

The dual bulb features a separate bulb for high and low beam functions. The top bulb operates in low beam to offer a wide arc of light. When using the highbeam the bottom bulb focuses light straight ahead while the top beam remains on to continue offering a wide arc of light. Kit includes housing, 55 watt low beam halogen lamp, 35 watt high beam halogen lamp and mounting hardware.

PCP Application

62808 Fits 1994-on Electra Glide and Road King models, and 1994-on FL Softails (equipped with chrome nacelle kit #67907-96B. (67864-04)

62807 Fits 1991-on FLSTC, FLSTF and FLSTN models. Does not fit models equipped with chrome nacelle kit 67907-96B. (67863-04A)



Chrome Bi-focal Headlamp

Includes mount and a 55-55W H-3 bulb.
59109

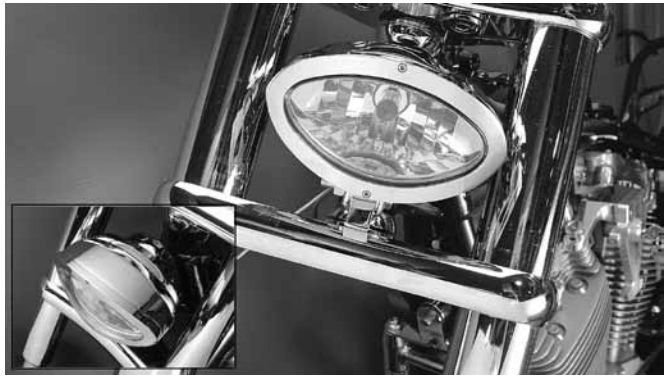

Axel's Oval Billet Headlight

Features stylish elongated oval design with a 60/55 H-4 bulb.
59894



Headlamp Housing Accessories

PCP	Description
21658	Handlebar top cover
21022	Top trim strip



FLST Smooth Chrome Fork Cover Kit

Three piece kit includes front panel and matching left and right panels. Fits all 2000-on FLST models.
62803 66440-05

Headlights



Custom Driving Light

Show chromed 4-1/2" driving light with heavy duty bottom mount. Complete unit with sealed beam and high beam indicator light. Sold each.

- 4593** Complete light
- 56105** 4-1/2" seal beam



Chrome Deco 4" Bottom Mount Head Lamp

Features a longer tapered shell fitted with a 12 volt H-4 60/55 watt bulb. Includes mount block and stud.

28334



4" Chrome Halogen Lamp

Includes H-4 12 volt 60/55 watt bulb and mount stud.

28335



4-1/2" Spotlamp Set with Visors

Spotlamps feature clear, sealed 12 volt beams and chrome visors.

- | PCP | Description |
|--------------|------------------------|
| 21683 | Spotlamp and visor set |
| 45466 | Visors only (pair) |

4.5" Billet Rocker Spot-lamp

Features 35/55 watt T-19 bulb and a billet rim which screws on for a positive seal.

59775



Bullet 5-3/4" Headlamp

Features H-4 unit installed and includes mount bracket.

59767



4.5" Torpedo Lamp

Features 35 watt bulb.

59776

Headlights



FX-XL 5-3/4" Stock Headlight

Headlight includes 12V sealed beam. Early style has 2 connections on back of shell. Late type replaces 67705-74 and has a rectangular hole in shell for wiring.

21687 1995-03 Black

59067 1974-89 Black



56236



56239

XL Chrome Headlight Assembly

Replaces the black housing on stock XL models. Includes centre stud, rubber grommet, chrome rim and a 55-60 watt H-4 unit.

PCP **Application**

56236 XL 1995-03 (68138-02)

56239 XL 1974-84



Chrome Stock FX-XL Head Lamp Shells

Late type shell has square hole in back of shell for wiring. Early type has wire connections on back side of shell.

3323 Early Shell 1954-73 models. (67766-72)

1338 Late Shell 1974-88 models (67705-74)

Wagner 12 volt 30/30w 5-3/4" Sealed Beam included.

6675 Early, 1954-73 complete (67733-72)

59068 As above, black

6676 Late, 1974-88 complete (67705-74)

59067 As above, black

28425 Chrome outer/inner door rim (67725-63) (pair)

5442 Rubber ring 1954-83 (67719-63)



5-3/4" Billet Lowered Spring Fork Headlight

12 Volt lamp is primarily for FXSTS models but can be used wherever 5-3/4" yoke mount lamps are used. Mounts 2-1/2" lower than typical bottom mount lamps.

59770

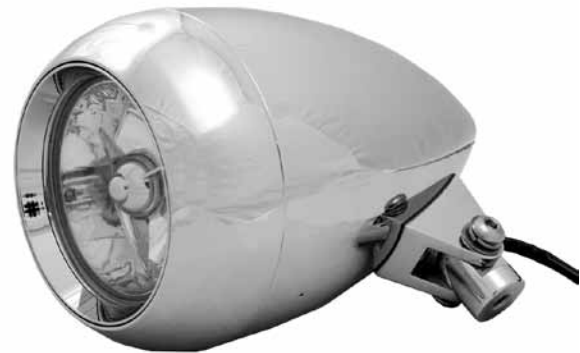

5-3/4" Protolyte

Includes 55/60 W H-4 bulb with tri bar lens, mount included.

21664



21787

HID (High Intensity Discharge) Unit

Fits 7" alloy cowl assemblies of FL and FLST models. Kit includes bulb and socket. Deflector cone must be removed on installation on glass integral lens that already has a deflector. Use with existing OE housing, bolt-in installation with nothing extra to purchase. Offers 7000cp white light.

PCP **Item**

21787 HID kit

17281 Bulb

Headlights



5-3/4" Billet Rocket Headlamp

Features H-4 bulb and bottom mount.

59768 60/55

21759 100/55



5-3/4" Chrome Bullet Headlamp with Grooves

Tear drop shaped headlamp features a chrome finish with milled groove design. Includes H-4 12V 60/55 watt bulb.

59236



5-3/4" Tear Drop Billet Headlamp

Available with pointed visor. Includes halogen bulb and features seamless style construction.

59293



5-3/4" Missile Billet Chrome Headlamp

Missile shaped lamp features built in pointed style visor and seamless construction. Includes halogen bulb.

59769

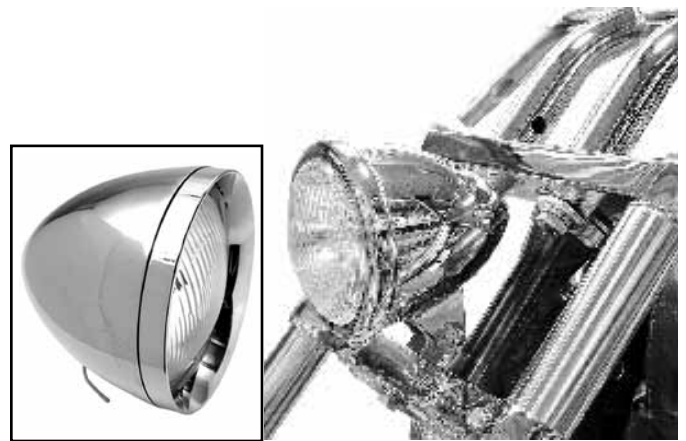

Chrome 12V Bullet Billet Headlamp

Features 12 volt bulbs with trim ring.

PCP	Size	Bulb
59180	5-3/4"	60/55

Billet Chrome Rocket 5-3/4" Headlight

59245



Headlights



56232



Custom Visor Lights

Manufactured from stamped steel with 3 decorative grooves on each side of the shell. This chrome light has a visor built into the bezel. Bulb is secured to the visor by 2 large springs. Complete with a chromed, universal mount and a 12 volt H-3 halogen bulb.

- 56208 5-3/4" Head light
- 56224 6-1/2" Springer Style Light
- 56117 Lens for #56224
- 56229 5-3/4" H-4 head light (no rib) w/high beam indicator



6489

3319

28424

5-3/4" Bates Style Sealed Beam Headlight

Comes assembled with beam, mounting eye bolt and indicator bulb.

PCP Application

- 6489 Complete bottom 12 volt, standard beam
- 56232 Complete bottom 12 volt, H-4 Bates replica
- 3319 Bottom mount shell only
- 27083 Mounting block for bottom mount lights
- 56202 Complete with 12 Volt Halogen seal beam
- 56203 Complete with 12 Volt replaceable Halogen bulb
- 56106 12 Volt halogen unit
- 28424 Rim only
- 27098 Mounting eye bolt



Chrome Halogen 6-1/2" Springer Headlight for Late Models

An updated version of the original headlight used on Springers from 1936-54. This beautifully chrome-plated headlight utilizes a high-power 12-volt, 55/100 watt halogen bulb, and mounting ears with an adjustable mounting block. Fits all FXWG and Softail®s (including FXSTS) from 1980-on, and many custom applications (will fit early springers).

- 56200 Headlight assembly
- 3552 Headlight trim rim with screw
- 56117 Glass lense only
- 17008 H-4 Quartz bulb 55/100 watt (each)
- 17007 H-4 Quartz bulb 55/60 watt (each)
- 56118 6 1/2" Quartz replacement beam unit

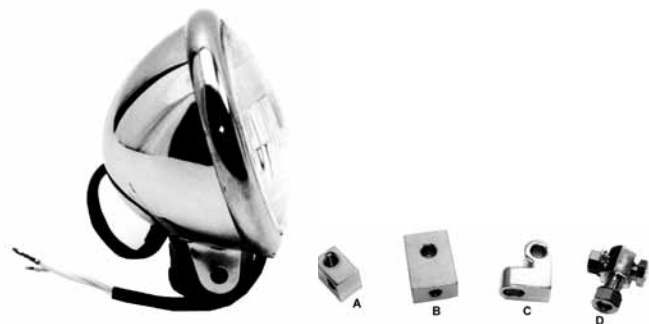

Bates 5-3/4" Headlight for FXWG-FXST 1980*

OEM type head light unit for Softails 1980-on, includes standard 12volt beam. Order mounting blocks separately.

PCP Fits

- 56201 Head light complete (67777-80A)
- 27095 (A) Block 1980-99 FXST-FXWG (67773-80A)
- 27096 (B) Block 1986-99 FLST (67768-86)
- 27097 (C) Block 1988-99 FXSTS (67771-88)
- 27098 (D) Universal block
- 73579 (B) Block 1997-on FLST



56205



56206

Paughco Teardrop Headlights

Lights are chrome plated and supplied with a seal beam. The 7" light features the springer fork styling with indicator light and the 5 3/4" is a teardrop style.

- 56205 5 3/4"
- 56233 As above, halogen H-4
- 56206 7" for Springer front forks

Headlights



21685

FXSTS Style 12 Volt Light

Features halogen lamp with chrome tear drop shaped shell with updated mounting design.

PCP Item

21685 1993-95 (67841-93)

27094 Bracket only (67892-93)



Chrome FLST Headlight Assembly 1986-95

Includes Sealed 12 volt, 7" lamp with a yoke mounting to fit lower triple tree. Mount block must be ordered separately.

56213 Complete lamp (67789-91A)

27096 Mounting block, zinc finish (67768-86)



59152



59152

Chrome Billet Headlamp

Features seamless type construction and includes a halogen bulb.

PCP Style

59152 Visor



Billet Chrome Halfmoon Headlamp

7-1/4" Deep housing features a clear bottom lens. Unit includes mounting block and H-4 bulb.

59353 Lamp

27095 Short bracket

73631 Long bracket

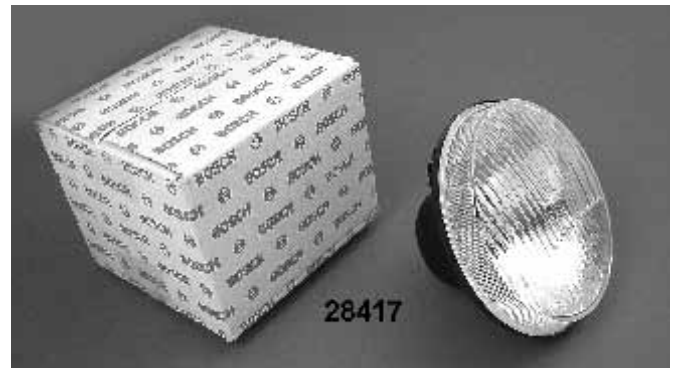

28417

Bosch Halogen Round Headlight

Available in 5-3/4" or 7". Includes 55/60 watt H-4 bulbs.

PCP Type

28417 5-3/4"

28418 7"

17274 55/60 H-4 bulb

17275 55/100 H-4 bulb

Headlight Brackets

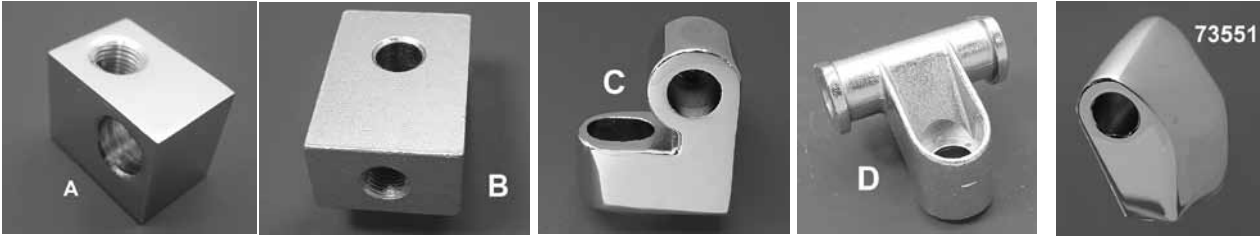

Headlight Mount Blocks

For use on 1980-on FXST-FXWG-FXSTS models.

- | PCP | Application |
|-------|-----------------------------------|
| 27095 | (A) 1980-on FXWG, FXST (67772-80) |
| 27096 | (B) 1986-96 FLST (67768-86) |
| 73579 | (B) 1997-on FLST (67768-97) |
| 27097 | (C) 1988-92 FXSTS (67771-88) |
| 27094 | (D) 1993-on FXSTS (67892-93) |
| 73551 | (E) 2000-on FXSTD (69163-00) |
| 73565 | (F) 1987-on XL, FXD (67919-96) |
| 73709 | (G) 1988-on XL, FXD |
| 73710 | (H) FXST Glides |
| 73711 | (I) FLST (fits 7") |



Extended Billet Headlamp Mount

Fits FXST models and allows lower lamp position. For use with custom lamps with narrow spacing.

73712



Chrome Headlight Extension Bracket
73529



Headlight Brackets

For custom applications with spring forks.

- | PCP | Type |
|-------|--------|
| 27018 | Single |
| 27020 | Dual |



Chrome Headlight Brackets

- | PCP | Fitment (C/C measurement) |
|------|--|
| 1330 | 3/8" 1948-84 FL (2-1/2") |
| 260 | 3/16" FX and XL extended front ends, lowers headlight for easier adjustment (4-1/4") |
| 5077 | 3/16" Adapts to bottom clamp pinch bolts of most front ends (4-3/4") |
| 3320 | Stock FL 1948-59 and for converting to late model wide glide look on stock and custom bikes (2-1/2") |
| 3322 | Bracket to mount headlights #6148 or #6149 to late model FXWG, FXST (installation requires removal of lower tree cone and drilling and tapping of lower tree on late 1985-89 models.) (4") |



Chrome FXWG-FXST Headlight Bracket

Mounts bottom mount head lites on fork, also covers rough casting on lower tree.

- | PCP | Years |
|--------|---------------------------------------|
| 1357 | Top 1980-E85 FXWG 4-Speeds (67773-80) |
| 1358* | Top 1985-on (67773-80A) |
| 27208* | Top 1993-on (45685-93) |
| 45203 | Bottom FXST 1984-99, FXWG 1980-86 |

*Does not have holes for front mounting. Mounts by headlight eye bolt only and acts as tree cover.

Visor and Mounting Brackets



Chrome Diecast Headlight Mounting Brackets

These heavy duty chrome diecast headlight brackets are available for most XL, FX, and FXR models.

1416 Two indicator holes (1/2" diam.). Fits FX, FXR, and XL models using 1/2" indicators 1975-85. (67809-75)

Note: When fitted to pre-1974 models indicator holes must be enlarged to 5/8"

870 No indicator holes. Fits XL, FX, and FXR models without indicators. (67805-86 and 67809-70)

45059 Four indicator holes. Fits late model FXR and XL models with four small diameter indicator holes (67805-86A, 67863-90)

59402 Large holes for FX Narrow Glide 1971-73

45260 Polished with slot fits XL STD, Hugger and 1200 1992-03 and XL 883 2004 (67805-92)

Chrome Headlight Visor Covers

Fits XL models 1960-on, FX and FXR models 1971-on with diecast headlight visors.

With Cutaway

899 Plain (not for 1996-on XL custom or FXDWG/Softail) 1991-05 FXDL (67871-85T)

4635 Louvered (67870-85T)

Without Cutaway

900 Plain, for models with indicator lights in speedo bracket 1991-05 Dyna (not for FXDWG or 1996-on XL custom) (67884-90T)

Headlight Visor Plugs 1959-88

Fits diecast headlight mounting visors.

2822 Sold in 5 packs (67830-59)



22163

Indicator Decal

22163 3 Hole decal, "beam/neutral/oil" (5 pk) (68464-86)



Headlight Visor Mount Bolts

Use on all FX, XL, FXR narrow front ends 1959-on.

5307 Acorn

5308 Cap

9783 Allen



Upper Bracket Cover

Fits 1988-on XL, FXD 39mm forked models when using a custom bottom mount headlamp.

62804

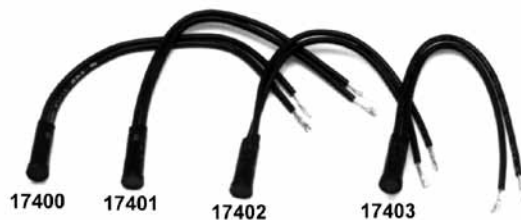

Indicator Lamps

Indicator lamps fit most 1983-on models and are supplied with 6" long leads. Sold each.

PCP Colour

17400 Red (68022-92A)

17401 Amber (67864-86)

17402 Green, neutral (68024-92A)

17403 Blue (68023-92A)

17404 Red, FXR 1986-on

17406 Green, turn signal (68021-92A)

12597 Speed Nut 1983-on (68608-83) (10 pk)

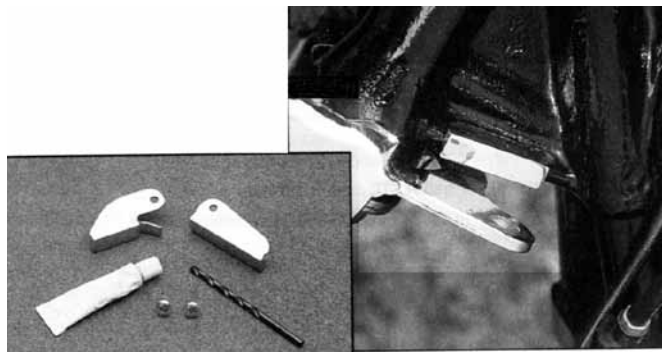

Chrome Sunvisor

Shields the LED's on the headlight mounting bracket from the sun.

44033

Headlight Connection 1996-on

Includes Deutsch fittings to connect to stock harness.

17411



Bulbs



PCP	Volt	Application (10 packs except where noted)
4966	6	Brake & taillight (1154) (68165-47)
4967	12	Brake & taillight (1157) (68165-64) Amber
28354		As above, clear
17003	12	As above but halogen (each)
4968	12	Directional (single) (68572-64A)
4974	12	Directional (dual) (68168-89)
4965	12	Bullet light (single)
4964	12	Bullet (dual filament)
5773	12	Speedo, 1984-on FXST, 1980-on FXWG, Hi-Beam Ind. 1975-on XL 1965-on FL, Speedo-Tach 1965-on XL (71090-64)
5774	12	Hi-Beam Ind. 1983-on FLH, 1984-on FXST, 1980-up FXWG, 1973-on all FX (71092-68A)
5775	12	Speedo-Tach 1983-on XL, 1984-on FXR, 1983-on FX, Hi-Beam Ind. 1983-on XL (53439-79)
5776	12	Turn Signal Ind. 1984-on FXST, 1980-on FXWG, 1965-on FL (68462-64)
5777	12	Tachometer 1974-on all FX high-beam indicator Bates style headlamp (71099-74)
5779	12	Mini-guage (ex: #737)
17242		Speedo & indicator lamp 1994-on (68024-94)

H-4 Quartz Bulb

Halogen type fits 5-3/4 plus 7" units sold each.

PCP Wattage (L-H)

- 17007 60/55
- 17008 100/55
- 17004 60/55 (Heavy Duty)

Caution: Do not touch any halogen bulb with bare hands during installation or replacement. The manufacturer advises that the light unit not be washed with a water hose as it is not a sealed beam unit.



2003-on Taillamp Bulbs

Are push in wedge style.

- 17255 Stock (10 pack)
- 17256 LED (each)



12 Volt LED Bulbs

Lights are vibration resistant providing long life. Available for brake lamp or lolly pop shaped for taillamps.

PCP	OEM	Colour	Application
59237	1157	Amber	Brake
59238	1156	Amber	Turn signal
59239	1157	Red	Taillamp



XENON Boosted H-4 Bulb

Bluish H-4 bulbs offer superior night visibility. The xenon gas is used to cool the filament and allow the halogen process to produce a higher light output. The special blue coating increases the whiteness of the light with only a trace of blue.

- 28355 60/55W
- 28356 100/55W
- 28352 100/90W
- 28377 130/90W

Caution: Do not touch any halogen bulb with bare hands during installation or replacement. The manufacturer advises that the light unit not be washed with a water hose as it is not a sealed beam unit.

Rainbow Strobe Insert

Allows lamp to radiate a soft, coloured light to alert drivers. For H-4 halogen bulbs (not included).

28353 Each



Red Brake 12 Volt LED Bulbs

Bulbs are not affected by vibration for long lift. Rotating type features LED's that rotate and reverse direction every two seconds and when brake light is activated the LED's pulse 2 times per second.

- 17041 1157
- 59048 1157 rotator

Sealed Beams

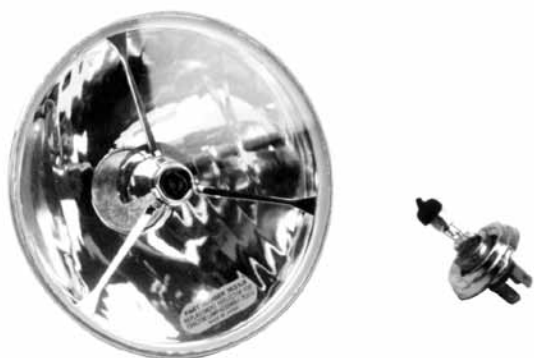

Tri-Bar Halogen Unit

Features early styling with a replaceable H-4 bulb, designed to fit into any existing 7" or 5-3/4" light assembly.

PCP# Description

- 56124** 7" beam with 60/55 bulb
- 17016** Bulb only for above 60/55 watt
- 56125** 5 3/4" beam with 60/55 bulb
- 17018** Bulb only for above 60/55 watt
- 56129** 4 1/2" spot lamp beam

H-4 Glass Headlight Assembly

Assembly features a dome shaped glass lens and includes a 55/60W bulb.

- 56234** 5 3/4" flat
- 59773** 5 3/4" round
- 56127** 7" round



7" Faceted H-4 Lamp Assembly

Features 60/55W bulb with parking lamp.
59771



Passing Lamp Bracket Covers

Brackets have a textured surface and stepped design. Fits all 1996-on Electraglide models except 2004 FLHTCSE.

- 64008** 68613-01

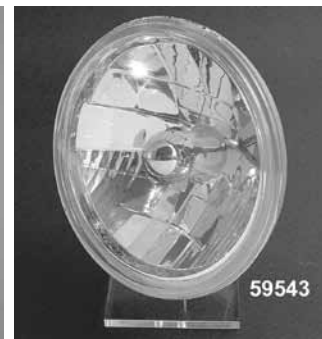

Diamond Cut Reflector Lamp Units

Includes 12v H-4 60-55 watt bulb.

- | PCP | Size | Type |
|--------------|--------|-------------|
| 59541 | 5-3/4" | Diamond cut |
| 59772 | 5-3/4" | Diamond cut |
| 59543 | 7" | Reverse cup |



H-3 Halogen Spotlamp Set

Includes 2 #55 W, 4-1/2" bulbs for installation in stock type spotlamp shells.

- | PCP | Type |
|--------------|-----------|
| 56122 | Clear |
| 59544 | Blue tint |
| 17280 | H-3 bulb |



FL Halogen Passing Lamp Kit 1970-on

- 66115** 68208-98

Sealed Beams



Round Seal Beams

Use on stock Sportster headlights, FX models, our custom K.D. highlights and others using 7" seal beams. Sold each.

PCP	Description
56104	5-3/4" 6 V (30/30w) (67717-59)
56108	5-3/4" 12V (30/30w) (67717-65)
56119	7" 6V (50/40w) (67717-48)
56109	7" 12V (65/40w) (67717-64)



Hi-Intensity Halogen Sealed Beams for Late Model Spot Lamps

These 4-1/2" clear non-fluted 12-volt halogen sealed beams have lots of candlepower to throw your way. The stock sealed beams are 22,000 candlepower and 30 watts with a beam spread of 12° horizontal and 7° vertical. These sealed beams are very bright.

56120	70,000 candlepower 37.5 watts - beam spread is 7° horizontal and 4° vertical
56121	110,000 candlepower 50 watts - beam spread is 7° horizontal and 5° vertical

Note: The installation of these sealed beams may cause an excessive drain on your charging system. Please check with a qualified mechanic beforehand. The use of these sealed beams may not be legal in your province, please check your local regulations before installing.

19 LED Turn Signal Bulbs

Replaces OEM 1156 and are sold each.

PCP	Colour
28378	Red
28379	Amber



Spot Lamp Bulbs

Single filament seal beam type. Replace 68726-64, in clear for stock OEM Spot lights 1964-up type.

PCP	Type
56110	12 Volt Clear
56111	6 Volt Clear
56114	12 Volt Clear Amber
56134	12 Volt Fluted Amber Lens
56115	6 Volt Fluted Lens Clear
56116	12 Volt Fluted Lens Clear (68674-69)
56105*	12 Volt Dual Beam Clear Fluted

*Fits PCP 4593 4-1/2" Light. All others fit our 6549 and 56210 lights.



Candlepower Halogen Headlights to Fit Harley

These Headlight Units are special heavy duty Units made for motorcycle use and made with (1) tab to fit the Harley with no problem. These are not Standard Automotive Type Units. Both units feature a 12-Volt 60/55 Watt replacement Bulb.

56106	5 3/4" Halogen Unit
56107	5 3/4" Halogen Unit (Heavy Duty)
56102	7" Halogen Headlight Unit
56103	7" Halogen Headlight Unit (Heavy Duty)



Halogen Sealbeams

Designed to out perform the standard, OEM quartz lamp used since 1982, this quartz-halogen sealed beam fits all 12-volt Harley® models using 5-3/4" headlamps from 1965-on. Manufactured to provide OEM specifications for brightness and vibration resistance.

PCP	Description
56100	5 3/4" 50/35 Watt (67698-81A)
56101	7" 65/35Watt (67774-83)

Spot Lamps



Chrome Dual Fog Lamp Kit

Features flat oval diecast lamps with 55 watt halogen bulbs. Chrome alloy clamps fasten to all 1-1/4" engine guards. (Not for XL 2004-on models with engine guard, FLTR or models with splash shields or fairing lowers.

66122 Set (68913-98B)



Chrome 12 V Spot Lamp Assemblies

Stock replacement spot lamp assemblies for OEM 68667-78. Fits FL, FLST and custom applications 1949-on. Sold each.

56130 Clear, fluted, sealed beam

56131 Amber, fluted, sealed beam

56132 Clear, non-fluted, sealed beam



Sealed Beam Passing Lamp Kit

Auxiliary passing lamps clamp-on to engine guard and include wiring, switch and instructions.

66116 Kit as shown (68250-80)

66115 Halogen passing lamp bulbs only (68208-98) (pr)



Spot Lamp Kits for Softails®

Designed for mounting passing lamps on all FLST, FLSTF models 1986-01. Replaces OEM 68249-86A. Kit includes mounting bracket and 2 passing lamps with fluted lenses.

56330 Complete kit (shown)

56306 Mounting bar only (58082-87)

56210 Spotlamp with fluted beam (each)

56211 Spotlamp with clear beam (each)



FLT-FLHT Spotlamp Shell and Bracket Kit

Fits 1997-on FLT/HT, 2004-on FLTR, FLHRS, 1994-on FLHR equipped with windshield. Requires use of OEM hardware kit 69235-04.

62809 69227-04A



Spot Lamp and Signal Light Kit

56332 FLST 1986-on with fluted beams

Spotlamps



Spot Lamp Support Bars

Chrome replacement spotlamp mounting bars.

- 65315** T/L Heritage FLST and Fatboy 1986-on (57852-02)
- 65316** T/L Heritage FLSTC/I 2002-06 (59082-02)
- 56306** FLST/F/N 1986-on (59082-87)
- 56301** FXST 1984-on includes brackets which mount to lower pinch bolts
- 56304** FXSTS 1988-96
- 44036** Clamp for above (each) (58114-88)
- 16323** Spacers for above (pair) (58115-88)
- 44037** Hole plugs for above (5 pk) (68796-88)
- 56305** FLHS 1986-on (68684-86)
- 16324** Spacer for above (pair) (67749-77)
- 66142** FLHR 1994-on (68712-94A)

Spotlamp Kits (Housing Kit not Included)

Includes one piece chrome mounting bracket, 2 spotlamps with genuine Wagner single filament clear seal beams and the necessary hardware to mount lamps to bracket and assembly to fork.

PCP	Application	Fork	Notes
56334	1980-on FXSW, FXST	Glide	D, E
56335	1986-99 FLST	Glide	D, E
56336	1986-99 FLST	Glide	C, E
56337	1986-93 FLHS	Glide	C, E
56338	1994-on FLHR	Glide	C, E

Notes:

- C. Includes amber turn signal assembly
- D. Turn signal not included
- E. Features a one piece chrome spotlamp bar.



Chrome V-Style Spotlamp Bracket

Replaces stock bracket.

PCP	Application
59372	1986-on FLST-FLSTF
59373	1994-on FLHR

Spotlamp Support Bar Kit

Chrome replacement spotlamp mounting bar. Fits FLST models (58082-87) including Heritage Softail and Fatboy 1986-on. Not Springer.

56302

Frenched Headlight Trim



Frenched Turn Signal Trim Rings

Fits front or rear on 1988-on FLT & FLST models

61084 Pair (69740-01)



Chrome "Frenched" Trim Rings

Trim rings gives the headlight a recessed look and will not work with headlamp visors.

Headlight Rings

- 61046** FXST/B, FXLR, Dyna 1994-on (not FXDF), FXSTC 1994-99, XL883/1200R/N/L/R 2004 (69623-99A)
- 59210** Preston as above
- 61048** XL 1963-03 (not 883C/1200C) (69625-99)
- 61047** FXSTSB 1995-97, XL 883C/1200C 1996-on, FXR 1999, FLSTS 1997-03, FXSTD 2000-on, FXSTS 1993-on, FXSTC 2007-on, FLSTC 2005-on, FXSTD 2000-07, FLSTSB 2008-on (69624-99A)
- 59190** Preston, as above
- 61049** FLSTC/F/N 1994-on (69626-99)
- 61050** 1983-on Touring models, FLHR 1994-on except Touring/Road Glides and 1986-on FL Softail (69627-99)
- 61107** FXCW/C 2008-on (69972-08)
- Spot Lamp & Turn Signal Rings**
- 61051** Spotlight 1962-on (69622-99A) (pair)
- 61084** T/L Flat turn signal front/rear 1988-on Touring (not 2004-on FLTR) and rear 1994-on FLSTC, 1994-97 FLSTN and 2006 FLST Softail Classic (69740-01) (pair)
- 59967** Preston, as above



Frenched Trim Rings

Offers the recessed look of the 1950's style trim rings. Available in original style and with visors.

PCP Application

- 21689** 1983-on Touring, 1994-on FLHR, 1986-on FLST (69627-99)
- 21690** With visor, as above (69733-05)
- 21691** 1994-on FLST (69626-99)
- 21692** With visor, as above (69734-05)
- 21693** With visor 1994-on FXST, FXD (69735-05)
- 21694** 1971-on FXE, 1982-on FXR (69625-99)

Headlight Trim



Chrome Visor Style Trim Rings

Customize the front of your bike with these chrome plated visor trim rings available for headlights, signal lights and passing lamps.

Headlamp

PCP	Application
29684	1983-on Touring except Tour Glide, Road Glide 1994-on FLHR 1986-on FL Softtail with nacelle #67907-96B Does not fit with #57800-00 fairing bra (69733-05)
29685	1994-on FLST/C/F/N (69734-05)
29686	1994-on FXLR, FXST/C/B 1994-on Dyna (not FXDF), 2004-on XL883/L/R, XL1200L/N/R 2005 VRSCB (69735-05)
29687	1996-on XL1200C, XL883C, 1999 FXR 1993-on FXSTS, 1995-97 FXSTSB 1997-03 FLSTS, 2005-on FLSTSC 2000-07 FXSTD, 2007-on FXSTC, 2008-on FLSTSB (69738-05)

Passing Lamp

29688	1962-on models equipped with original equipment or accessory auxilliary lamp kits (69732-05) (pairs)
--------------	--

Front and Rear Turn Signal w/Flat Lens

29689	1988-on Touring (not FLHX, FLHRS, 2004-on FLTR) 1994-on FLSTC rear, 1994-97 FLSTN, 2006 FLST and FL Softtail models with #68413-99 or 68412-99 front turn signal kits (69749-05) (pair)
--------------	--

Chrome Bullet Style Headlight Trim

Use existing beam and headlight rim to hold trim in place.

PCP	Application
28306	4.5" Spotlamp
28307	5 3/4" Headlamp
28308	7" Headlamp



Chrome Headlight and Taillight Rims.

PCP	Description
28424	5 3/4" Custom head lights
5499	4 1/2" Spot Lamp (68725-62)
28425	Light Rim XL 1963-88, FX Inner 71-* (67725-63)(pr)
5442*	Rubber ring (for rims above) (67719-63)
3569	7" Headlight ring all FL's 1949-59 (67726-48)
4038	7" H/light ring & spring all FL's 1960-* (67712-60A)
28426	Headlight rim 1983-86 FLT (67712-83)
28427	Headlight rim FLST 1986-* (67740-87)
28430	1986-on FLST inner headlight door (68050-93)
28493	As above, inner door and bucket (68050-93A)
28431	7" x 3/4" deep inner h/light door 60-84 (67726-71)
4960	7" Inner headlight ring FL 1960-84 (67765-60)
3568	7" Inner headlight ring FL 1949-59 (67719-48)
28428	Taillight rim 1955-72 (68086-55)
28429	Tombstone taillight 1947-54 (68085-47)
19346	Springer spot lamp bezel (68668-38)

*NOTE: Fits between two halves of #28425



Chrome 'ET' Lamp Insert

Custom insert bolts on to existing headlamp or spotlight. Headlamps and spotlamps sold separately. Sold each.

45304	4-1/2" spotlamp
45305	5-3/4" headlamps



Chrome Light Visors

Smartly designed and easy-to-install chrome visors

PCP	Application
439	7" FLH headlight (each) (67752-77T)
1420	5-3/4" headlight, XL-FX Bates (ea) (67750-88T)
436	4" FLH spotlight (pair) (67783-78T)
438	1 3/4" Bullet light (10 pack) (67785-78T)
435	1963-85 FL turn signal (pair) (67786-86T)
28300	1986-on FL front turn signal (pair) (67734-88T)
28301	1986-on FLHT turn signal, top mount hole (pair) (67737-88T)
1710	FX-XL taillight (each) (68006-83T)
45060	FX-XL taillight, louvered (each)
4949	FXST taillight (each) (68012-88T)
44402	Visor mount kit for FLHR (67761-96)



Taillight Covers / Visors

Chrome taillight covers feature a cut-out license plate illumination. Covers fit over the taillight on 1973-on models.

1710	FX, XL, Smooth (68006-83T)
45060	FX, XL, Louvered
4949	FXST-FXWG (w/inverted light), smooth (68012-88T)

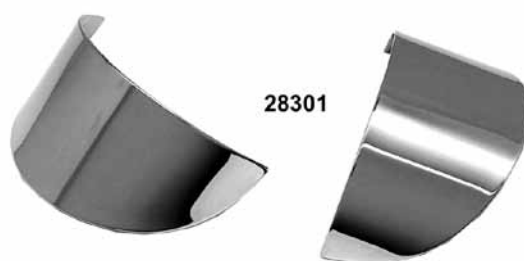

Chrome Spot Lamp Trim Rings

Use of these visors allows the installation of visors on 1987-on models. Sold in pairs to replace 68775-93T.

45465	Rings
45466	Visors



Chrome Deco Spot Lamp Visor

Visors have a beaded edge and are sold in pairs.

45468

Late-Model Turn Signal Visors

We offer two versions of turn signal visors which will fit late-style front or rear housings on most "full Dresser" and Heritage Softail® models 1986-on. Complete with mounting hardware where necessary. Sold in pairs.

PCP	Description
28300	Fits the front of all FLHT/C, FLHS and FLSTC models 1986-on (67734-88T)
28301	Fit the front of 1988-on FLTCs and the rear of all FLTC, FLHT/C, FLHS, FLST/C, FXRD and FXRT models 1986-on (67737-88T)

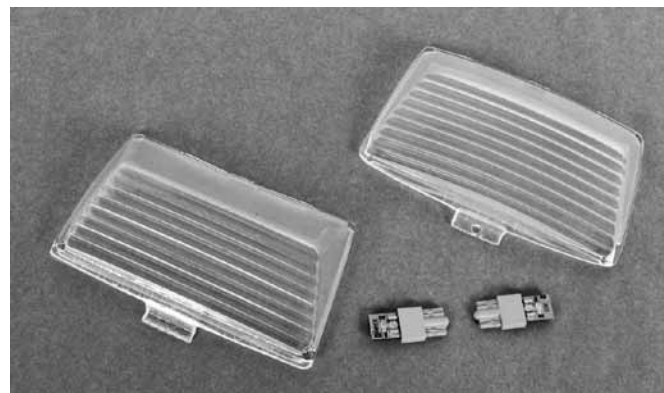

Fender Tip Lens Kit with LED Lights

Kits feature clear or smoke lenses with red and amber LED lamps. Fits 1980-on FLT, FLHR, FLHS, FLHT, 1986-08 FLSTC, 1993-96 FLSTN. Will not fit FLST/S/C, FLHRS, FLHX and FLTR or models equipped with clean style front fender.

PCP	Colour
29527	Smoke
29528	Clear

Fender Lights

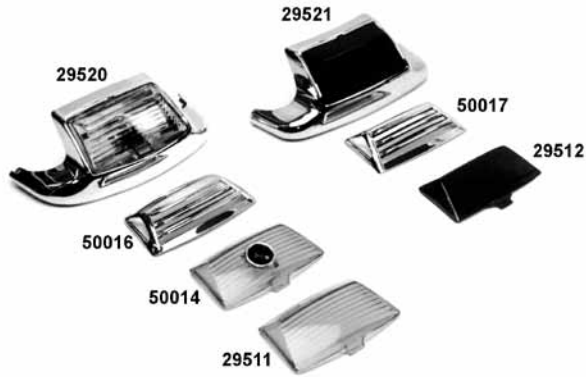

Rear Fender Tip with Light 2000-on Models
29546 59672-99

Lighted Fender Tips

Replaces OEM items on 1979-on FLT in chrome plastic with lights installed.

- | PCP | Description |
|--------------|----------------------------------|
| 29520 | Front fender light (59082-79) |
| 29511 | Front amber lens only (59180-80) |
| 29521 | Rear fender light (59658-79) |
| 29512 | Rear red lens only (68046-79) |
| 50016 | Front fender tip grill |
| 50017 | Rear fender tip grill |
| 50014 | Front amber lens with blue dot |



FLT Front Fender Tip with Light 2000-on
29547 68706-00



T/L Chrome Fender Tip Lens Grill Set

Chromed plastic grill set fits 1980-on FLT, FLHT, FLHS, FLHR and 1986-on FLSTC, FLSTN models. Does not fit FLSTS.

63035 59081-96



Front Fender Rail Light Kit

Increase your visibility using our 12 volt amber running lights that mount to the front fender rail on FL, FLT and Heritage Softail models 1973-on. Installation is quick and easy, just wire the kit to the stock fender tip light. Sold in pairs.

28305



T/L Chrome Skull Fender Tip Lenses

Chrome fender tip lense kit features front amber and rear red lenses with a translucent skull silhouette. Fits 1980-on Electra Glide, Tour Glide, FLHS, Road King (except Road King Classic and FLHRS) and 1986-on FLSTC and FLSTN models.

29642 59651-01



Replica Fender Lamp

Classic style 12 volt lamp replaces 5926B-68 on 1968-on FLH front fender and late side car fenders 1979-on.

- | | |
|--------------|---------------|
| 28333 | Lamp |
| 23148 | Gasket (each) |



LED Fender Tip Lamps

Fit 1980-on models

- | PCP | Type | Colour |
|--------------|-------|--------|
| 59340 | Rear | Red |
| 59341 | Front | Amber |

Taillights



Late Style Tombstone Taillight

Fits on most FLSTS models 1997-on, or custom applications.

28344 Taillight with license plate bracket (68233-97)

28345 Bracket set

23072 Lense gasket (5 pack)

23073 Lamp pad (each)

28149 Red lense



Tombstone Taillight kit for 1973-on Stock Fender

New classy look for 1973-on FL style fenders. This kit includes our 798 chrome diecast taillight and a new custom mount base (with gasket & hardware) to place on the raised stamping of 1973-on rear taillights. Fits 1973-on style Big Twin rear fenders for FL, FLT, FLHT, FLHS, Road King, Fat-boy, & Heritage models and XL.

28241 Complete kit 1999-on

28328 Complete kit 1973-98

28329 Mount base only 1973-98

Note: 28241 fits 1999-on stock fenders with rectangular cut out for taillamp.

Box Style Custom Taillight

Chrome diecast taillight with universal 2 bolt mounting for most applications.

4962 Complete unit



Chrome License Plate Bracket Kit

Includes stock style 3 hole bracket assembly, license backing plate, frame and 4 krommets. Order taillamp and blue dot lense separately.

59778



Late Style Tombstone Style Taillight Assembly

Chrome die-cast light is larger than conventional tombstone taillights. For use with chrome license plate bracket to fit 1973-98 models. PCP # 28344 is for smooth rear fenders and includes a chrome cross bracket.

PCP Application

28242 1973-98 Taillight

28381 As above, LED

28243 1973-98 Taillight

28344 Smooth taillight FLSTS 1997-on

28244 1999-on XL, FXD Taillight

28382 As above, LED

Taillights



Chrome Diamond Rear Light

Diecast, 12Volt light has red lense and chrome body. Bolts to stock FXWG, FXST or cateye mount holes.

- 28254** Complete light
- 59110** Complete light LED
- 56590** Red lense only



Deco Style Lay-Down Taillight Assembly

Fits in stock location.

- | PCP | Application |
|--------------|-----------------------------------|
| 28357 | 1973-98 Assembly |
| 56591 | Red lense for 1973-98 w/window up |
| 28358 | 1999-on Assembly |
| 28156 | Red lense for 1999-E03 |
| 28359 | 1999-on bracket only |



Complete LED Taillight Assembly

Assembly includes chrome base, lens, wire and bulb. Uses speed nuts for mounting as stock. Fits 1973-92 FX-FL-XL.

- 59111** 68008-73A



Chrome Deco Taillight Mount

Designed to accept Lucas or cateye style taillights with license plate frame.

- | PCP | Application |
|--------------|---------------|
| 59379 | FXDWG 1993-99 |
| 59782 | FXDWG 2000-on |
| 59783 | FXST 2000-on |



T/L 1993-98 BT Taillight

- 28391** Replaces 68048-93B



Mini Round Taillamp

- Includes brake and taillamp 12V bulb.
- 59384**

Taillights



FX-FL-XL 1973-on Taillight

PCP	OEM	Item
12500	7501	Mount nuts (10 pk)
406	68008-73A	Complete light 1973-92
28391	68048-93B	Complete light 1993-98 BT and XL 1990-98
28154		Complete light 2003-on
25181	68025-73	Lense gasket 1973-89 (each)
24559	68026-99	Lense screws 1999-on XL (10 pack)
24520	68026-73	Lense screws BT 1973-on, XL 1973-98 (10 pk)
56589	68140-99	Lense only 1999-on XL-FXD
56588	68033-90	Lense only 1990-98
1291	68034-77	Lense only 1973-89
28194		Lense only L2003-on
23002	68123-73	Beaded rubber base gasket (each)
79493	68123-73	Base gasket to fender (10 pk)
28354	68165-64	Clear bulb (10 pk)
4967		Amber bulb (10 pk)



"Cateye" Chrome Taillight -Universal

Heavy-duty, almost vibration proof.

884	Classic 12-bolt Cateye taillight with red lense
4946	Cat Eye red lense with jewelled blue-dot lense
1265	Replacement standard red lense
1266	Replacement license plate clear lense
44110	Chrome stamped grill
44111	Chrome stamped grill
23040	Gasket (10 pack)



Blue Dot Type Lense

Lense with Blue Dot installed.

1256	1973-98 Acrylic
28199	1999-03 FLT
28200	L2003-04 FXD-XL accepts wedge bulb
4945	Tombstone
4946	Cateye
4942	XL-FX Signal (Amber) 1973-85 (each)
4943	FL-FLH Signal FLH 1963-85 Red (each)
56603	FL-FLH Signal FLH 1963-85 Amber (each)



Taillamp Lense

Fits 1973-on FXD-FLT models. Lense includes built-in reflector.

28155	Stock 1999-E03
28156	Lay-Down 1999-E03
28157	Lay-Down with blue dot 1999-E03
56591	Lay-Down w/up window 1973-98
28148	As above, w/down window

Stock Red Taillamp Lense

PCP	Application
1291	1973-98 XL, FX, FXST
28155	1999-E03 FLT, XL, FXD, FXST (V-Twin)
28194	L2003-on FLT, XL, FXD, FXST



Lay Down Taillamp Lense L2003-on

For wedge type bulb to fit all FLT, FXS, FXST, XL models. Has notched area for bulb socket.

PCP	Colour	Plate Window
28195	Clear	Up
28196	Red	Up
28197	Clear	Down
28198	Red	Down

Taillights



Smooth Taillamp Lenses

Fits 2000-on FXSTD and 2002-on V-Rod.

FXSTD	V-Rod	Colour
17268	17271	Red
17269	17272	Clear
17270	17273	Smoke



Stock Style Clear Taillamp Lenses

For use with red LED bulbs.

PCP	Application
28190	1973-98 FX-XL, 1999 FXST
28191	1999-E03 FLT, XL, FXD, FXST
28192	1999-on FLT, XL, FX
28193	2003-on FLT, XL, FXD, FXST



LED Radium Style Taillight Assembly

PCP	Application
21679	Complete taillight assembly with installed LED and 36" wires to fit 1978-98
28192	1999-on Lens/LED unit with 4" wire and OE plug

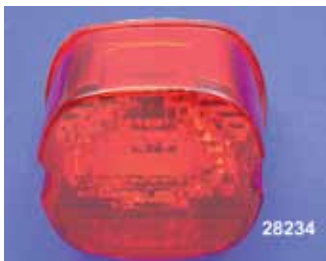

1990-03 FLT Laydown Taillight Lenses

Includes reflector assembly and downward plate window.

PCP	Application
28234	Red
28235	Clear

Chrome Grill for Custom Tail Lights

Chromed, stamped steel custom tail light grill comes ready to install custom taillight lens, with or without blue dot.
45068



Chrome Taillight Grills

2932 Fits all models from 1973-on



Custom Taillight Lens

Custom lenses feature a three dimensional design.

1973-on
56585 Lightning bolt design

FXST, FXWG, FXDWG 1980-on
56587 Lightning bolt design

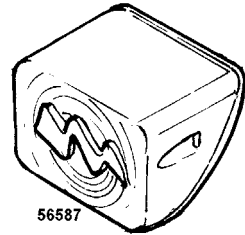

Blue Dots

Blue dots with chrome rims

4500 Blue Dots (pair)
3479 Gold Dots (pair)



44114



44115



Stylish Chrome Taillight Grills

44114 Eagle design
44115 Slotted cateye grill
44116 Slotted tombstone grill



44116

Taillights



Side Mount Cateye Taillight Kit

Features die cast cateye taillamp with chrome recessed plate.
59151



Chrome Side Mount Taillight Kit

Mount bracket replaces left side axle adjuster on 1986-on Softail models.
59127



Cateye Taillight Mount Kit FXWG, FXST

- 57302** FXWG 1980-on, FXST 1984-99
- 21680** FXDWG 1993-99
- 884** Cateye taillight only
- 1231** Bracket only FXWG-FXST 1980-99
- 59379** Bracket only FXDWG 1993-99
- 59782** Bracket only FXDWG 2000-on
- 59783** Bracket only FXST 20000-on



59124



59125

Mini Cateye Taillight and License Plate Bracket Assembly

Fits 1980-99 models.
59124 Kit
59125 Taillight only

Vintage Chrome Tear Drop Taillight Assembly

Diecast assembly includes steel strap license plate bracket.

- 59176** Lamp with bulb
- 59582** LED lamp



Round "Stop" Taillamp

Round style taillamp like the one's used on early bobbers.
59881



Skull Cateye Taillight

12V light features classic oval design with raised skull detail lense.
59149 LED

Taillights

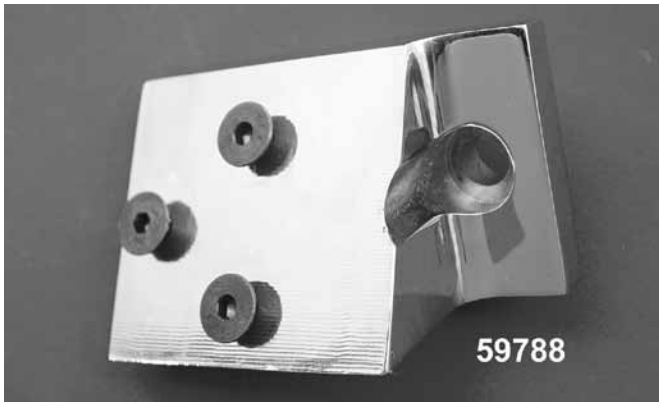

Chrome Billet Side Mount Brackets

Fits into stock swing arm.

PCP	Application
59788	1991-on FXD
59789	1973-84 FX, FL and 1979-96 XL
73685	5/16 x 24 Nut set



Mini Cateye Taillight With Plate Bracket

Chrome taillight measures 16cm x 4cm and has an alloy plate bracket.

59126



Billet Side Mount Bracket

PCP	Style
59790	Flat
59791	Curved
73687	3/4" to 1" Bushing



Chrome Tombstone Taillight

Includes skull rim lens grill, diecast chrome taillamp license plate bracket and chrome plated steel adapter plate which will mount to all BT and XL stock rear fenders.

PCP	Item	Application
59793	Taillamp w/rim	Custom
59794	Kit	1973-98
59795	Kit	1999-on



Skull Face Tombstone Lamp

Features diecast construction with LED board.

PCP	Colour
59796	Red
59797	Clear



Sparto Style Taillight

Features die cast housing and gasket for fender mounting.

PCP	Description	Type
28519	Chrome	LED
28520	Polished	Bulb
28521	Chrome	Bulb
28522	Black	Bulb



Big Eye Taillamp

Constructed of chromed ABS.

59579	Clear LED
59580	Red bulb

Taillights



Radii Chrome Oval Taillamp Assembly

Features chrome bracket with billet oval taillamp with LED red lamp and amber LED directional signals installed.

PCP	Application
59375	1980-99 FXWG, FXST
59376	2000-on FXWG-FXST
59377	1993-99 FXDWG



Cateye Taillamp w/LED Board

Features smooth red lense with LED board installed. Chrome body has stepped design for updated look.

59385



Chrome Oval Taillight Bracket

71017 Fits Fat Bob fenders on Dyna Wide Glide 1993-on



Chrome Cateye Sport Lamp

59792 LED



Chrome Radii LED Taillamp Assembly

Taillamp features LED matrix with built in amber turn signal bulbs. Measures 6" x 2-1/2" at the centre.

59262



59971



59973

LED Lady Luck Taillamp Assemblies

For Softail models with 3/4" or 1" axle.

PCP	Style
59971	Horizontal
59972	Vertical
59973	Curved



59972



28350



28351

Replica Sparto Taillight

Lamps feature a red lense with a clear license plate window.

28350 Polished

28351 Chrome

Taillights



Chrome LED Slice Side Mount Taillight

Fits 1986-on FXST models.
59005 Complete assembly
59150 Side bracket only



Chrome Side Mount Taillight Kit

Features verticle plate area with cateye LED taillight for 1986-on FXST.
59004



Chrome Side Mount LED Taillight Assembly

Assembly features billet oval LED lamp with a curved license plate area to fit 3/4" or 1" axle.
59112



Chrome Vertical Taillight Assembly

Includes LED slice taillight for 1986-99 FXST models.
59144 Flat
59108 Curved
28183 LED Array for #59144



5/8" Shoulder Nut

Nut allows mounting of billet side mount tail lamp assemblies to early model rear axles. Fits billet type with 1" to 3/4" sleeve type mount brackets.
12648



59145



28319

2003-0n Taillamp Bulbs

Are push in wedge style.
17255 Stock (10 pk)
17256 LED (each)



Chrome Vertical Taillight Assembly

Features total billet construction and includes LED billet oval taillight with flat lense for 1986-on Softails
59145 Assembly
59274 Lamp only
28319 LED array only

Taillights



Radii LED Fender Mount Taillamp

Features Billet bracket with Billet oval LED lamp. With built in LED amber turn signals.
59399



Maltese Cross Taillamp Kit

Includes light and chrome backing plate for sissy bar or side mount use. Side mount bracket is sold separately to fit 5/8" axles.

PCP	Description
59387	Kit
59150	Side mount bracket only

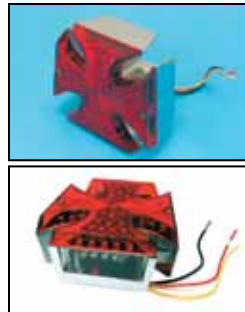

Maltese Cross Lights

Fits flush mount to steel backing plates.

PCP	Type/Finish
59386	Maltese cross light
59113	LED Maltese cross light



Taillamp and Mount Plate Set

Includes lamp and backing plate which may be a sissy bar or side mounted (with purchase of separate bracket).

PCP	Type	Size
59381	Lucas	4" x 7"
59382	Lucas	5" x 7"
59383	Cateye	4" x 7"



Chrome Adjustable Bobbed Taillight Bracket

Plate can be adjusted from 7.5" to 9" wide to accept similar taillights.

59044



Side Mount Taillamp Clamp Sets

Will mount to rigid frame rear sections. Accepts three bolt plate and lamp assemblies.

PCP	Size
73574	1"
73575	1-1/8"
73576	1-1/4"
73577	1-3/8"

Taillights



Chrome Billet Side Mount Assembly

Features 2.5" square LED maltese lamp.

PCP	Type
59389	Vertical
59390	Horizontal
28443	LED array board



Billet Chrome Taillamp Support Bracket

Features LED light. Rail mount fits 1997-on FLT models.

PCP	Style
59248	Plain
59397	Skull
59398	Diamond
59550	Slice

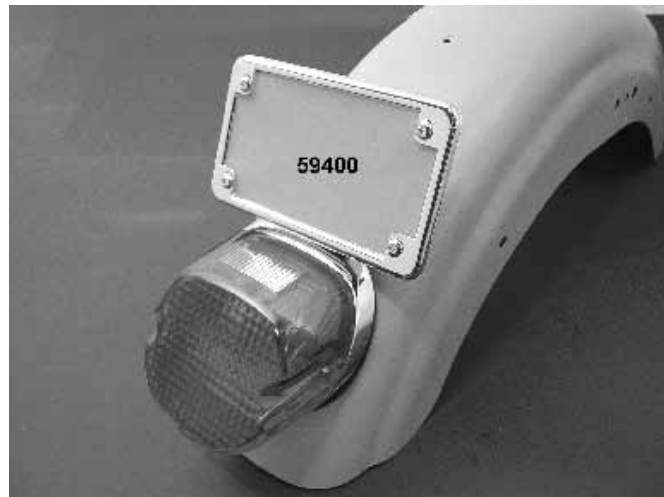

Deco Style Lay Down Taillamp and License Plate Mount Kit

Includes complete lamp and die cast plate holder with rubber mount block. Mounts to FX-FXD models.

59400	1973-98
59401	1999-on



Chrome Billet Fender Mount LED Taillamps

Mount to 3 bolt position on stock fenders. Rubber pad included.

59043	Slice
59396	Skull



Taillights



Chrome Billet Curved Mount Lamp Assembly

Mounts to outboard starter on BDL and Primo 3", 3-3/8", 3-1/2" drives.

PCP **Style**
59591 **Slice**



Iron Cross Side Mount Lamp Assemblies

Fits 1986-on Softail models with 3/8" or 1" axle.

PCP **Style**
59587 Vertical
59588 Horizontal
59589 Curved vertical



LED Maltese Billet Tail Light Bracket for Fender
59549



LED Maltese Oval Taillamp

Features red lens with 2 clear LEDs for plate illumination. Mounts where any cateye taillight will mount.

59168

FXST Maltese Cross Lamp Kit 1980-99

Features clear lense with red LED units and clear LEDs for license plate illumination.

PCP	Item	Colour
59779	Kit	Clear
59780	Lamp only	Clear
59781	Lamp only	Red

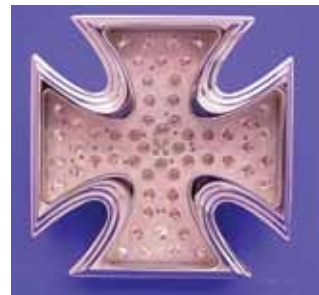

4" Maltese Cross Billet Taillamp

Features rotating centre portion acting as brake lamp. PCP #59785 features a red lense and all red LED. PCP # 59784 has a clear and red lense and has red and blue LEDs.

PCP	Lens
59784	Clear
59785	Red

Taillights



59218



59216



59217

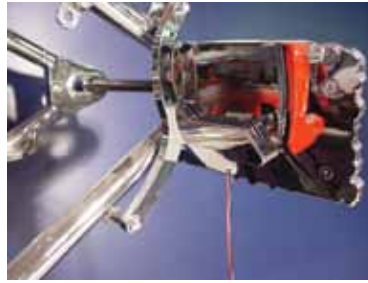

FXST Side Mount Billet Taillamp Bracket 86-99

Fits left side of FXST 1986-99 or can be attached with clamps. Order clamps separately. Utilizes 3-bolt plate and lamp assembly. Builder must use clamps or fabricate brackets to attach to frames. Lamps include 3 hole plate to mount.

PCP	Item
59391	Bracket
59393	Plain lamp

Diamond LED Taillight Assemblies

Side mount units accept a 3/4" or 1" axle. Lights feature an installed full 12 volt LED array.

PCP	Type
59216	Curved verticle
59217	Verticle
59218	Horizontal
59786	Verticle diamond light
59787	Horizontal diamond light
59220	Diamond LED light only

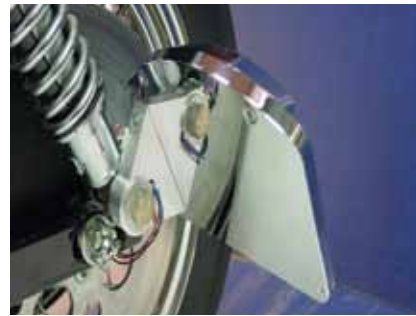

21660

Billet Side Mount Brackets

Features 1/2" hole with 3/8" adaptor bushing so bracket can accept either. Available with 3/8" or 1/2" mount hole to fit shock bolts on swing arm models. Use for mounting side mount units on FXR-FXD models. Brackets fit flat backed billet lamp assemblies.

59388 3/8" or 1/2"



21661



21662

Side Mount Brackets Only

Will mount vertical flat side mount units to FXST or FXD primary or FXST pivot pin on left side.

PCP	Type	Application
21660	Primary	1989-06 FXST, FXD
21661	Pivot	1987-99 FXST
21662	Primary	1965-88 BT



Chrome Billet Fender Mount Taillamp

Features LED slice tail lamp. Unit bolts in 3 hole license plate bracket location.

28348

Taillights



59917



59918



59919



59921

Katzezy LED Taillight Assemblies

Available as side mounts on 1986-on FXST units or as taillight only. Taillight features full LED with license plate light. Mounting holes are 2" centre to centre to fit where cateye or similar lamps will install.

PCP	Style
59917	Vertical
59918	Curved
59919	Horizontal
59920	Taillamp only
59921	Fender mount



Vintage Sconce Taillamp Assembly

Features die cast construction with built-in signal lamp set to fit 1973-98 models.

59888

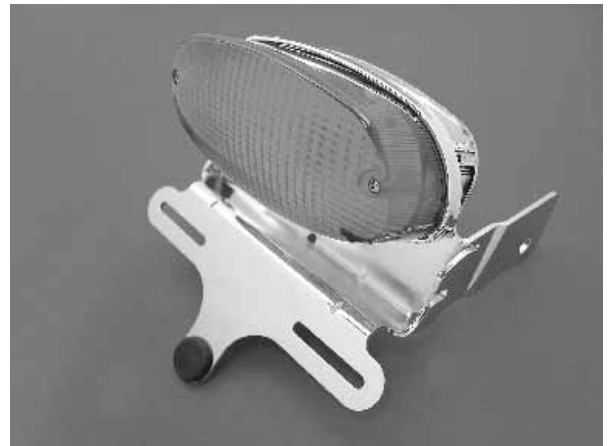

Oval Taillamp Assembly

Assembly includes chrome bracket and stock oval taillamp to fit bobbed fenders.

59889 1980-99 FXST

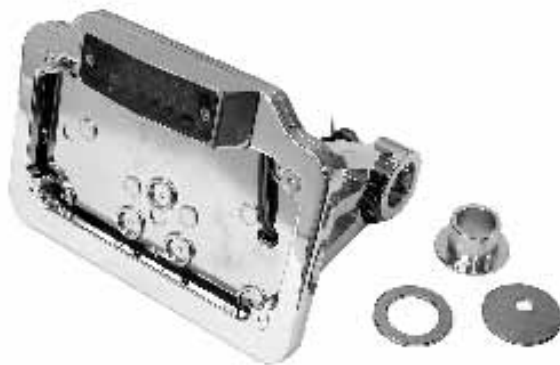

FXST Billet Chrome Sidemount Taillight Assembly

Taillight assembly features smooth chrome license plate frame.

59247



FXST Chrome Skull Sidemount Taillight Assembly

Assembly features licence plate frame with chrome plated 3-D skull motif.

59246

Taillights



Chrome Radii Side Mount License Plate
 Side mounting assembly fits 3/4" axle on 1986-on FXST models.
59232



Chrome Vertical Taillight Assembly
 Includes LED slice taillight for 1986-on FXST models.
59144 Flat
59108 Curved



Chrome Billet License Frame
 Fits 4"x7" plates.
59403 With red LED top lamp
21712 With mini LED top lamp



Billet Vertical Side Mount Assembly
 Features oval LED lamp with billet clamp, 1-1/8" ID to fit FXST or rigid frame sections on right or left sides.
21673



Odins Lamp Assembly
 Unit features 3 bolt mounting on rear side to mount to stock rear fender 3-hole plate pattern. Lamp shown installed on FXST rear section bracket. For FXST models.
PCP Description
21671 Vertical curve
21672 Lamp only

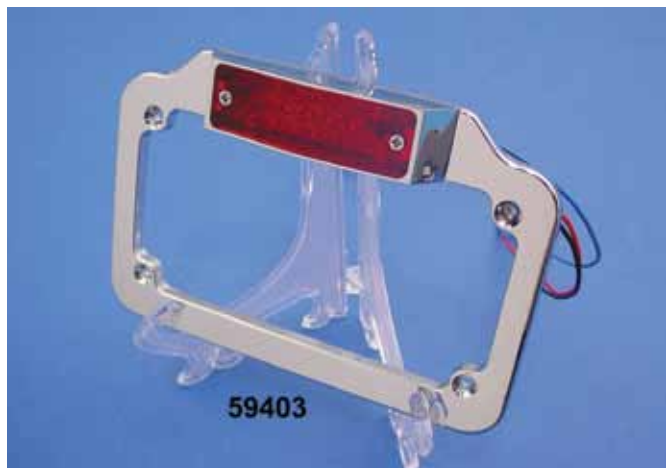

Taillights



Spike Taillight
With license plate lamp.
21667



Thin Cateye Taillight
LED taillight is only 3/4" thick.
21668



Incurvate License Plate Bracket
Includes LED diamond lamp to fit 1986-on FXST models with 3/4" or 1" axle.
21707



21676

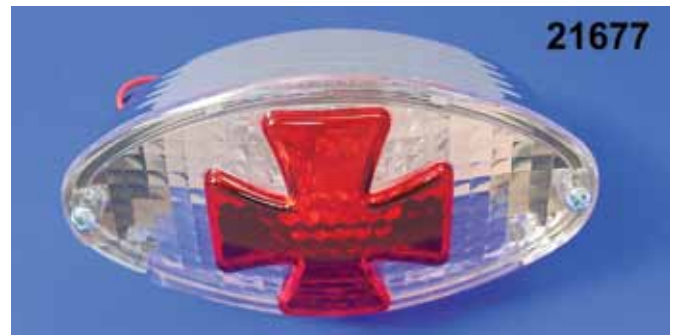

21677



Curved License Plate Frame
Wraps around fender edge to mount to turn signal bar mounts under stock taillight on FL models. Use with bottom window taillamp lens.
21675



21678

Oval Taillights with Maltese Cross Inset

PCP	Lens
21676	Red with clear cross
21677	Clear with red cross
21678	Red with red cross

License Plate

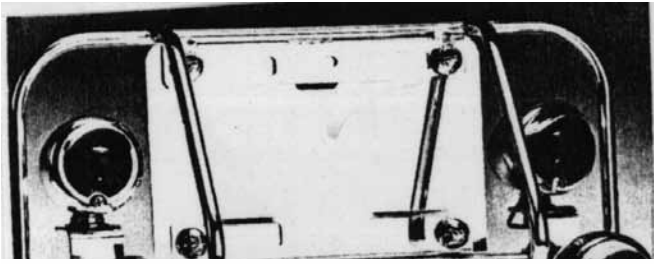

56347



Dresser Light Bar (lights not included)

This custom light bar (use any 4 marker lights) is the ultimate way to light up the rear of your bike for safety and that dressed-up look. Wire it as a brake or running lights. Assembly includes bar, chrome backing plate to fit most license plate sizes.

- 6490** Larger plates (8x4) without lights
- 56347** Light bar with 6 red bullet lights. Fits FL 1977-84, FLT, FLHT 1980-96. (68524-79)

4591



2032

Custom Taillight and License Mount

Side mounts are universal—fits right or left side. Heavy-duty steel, beautifully chromed.

- 2032** Side mount taillight
- 4591** Fender mount taillight
- 2236** Taillight only
- 4358** Lense only



Doss Circuit Board Taillight Adaptor Bracket

The adaptor allows the replacement of stock taillight on 1998-on rear fenders.

71020



Chrome Tail Lamp and License Plate Holder

For 7-1/4" x 4" plate size. Accepts type of taillamp as noted.

- | PCP | Type |
|--------------|--------------------------|
| 59531 | Lucas and Cateye |
| 59532 | Lucas (5 x 7) |
| 59533 | Lucas (recessed) |
| 59534 | Cateye (recessed) |
| 59535 | Maltese Cross (recessed) |
| 59536 | Maltese Cross |
| 59537 | Side mount bracket |

Chrome License Plate Backing Plates

- 59538** Smooth
- 59539** Louvered



Chrome Bushing Kit

Allows use of 3/8" or 1/2" bolt mounting of FXST type billet side mount assemblies.

73594

Chrome License Mount Square

45218



License Plate



Taillight Brackets for Fat Bob Fenders

These taillight brackets are reproductions of the OEM brackets fitting FXWG and Softails® from 1980-on.

PCP Description

- 28510** Black taillight bracket (59993-80)
- 28511** Chrome taillight bracket (59993-80TA)
- 62020** Red reflector (each) (59988-72)

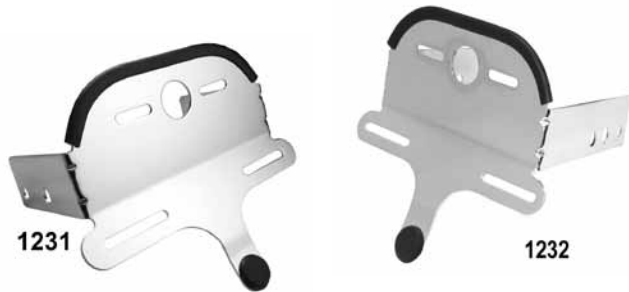

WideBob1 & 2 Custom Taillight Bracket

We offer the WideBob1 or WideBob2 under fender taillight and license plate mounting brackets for custom applications. Extra wide slotted mounting holes allow many custom taillights to be installed. The WideBob1 bracket works best for FX/XL width rear fenders, such as #6025 while the wider WideBob2 custom bracket works best for FL/FXWG/FXST width rear fenders such as #6006. **Lights not included.**

- 1232** WideBob1 bracket (6.5" wide, 3 hole) FX&XL
- 1231** WideBob2 bracket FXWG-FXST (7" wide, 2 hole)

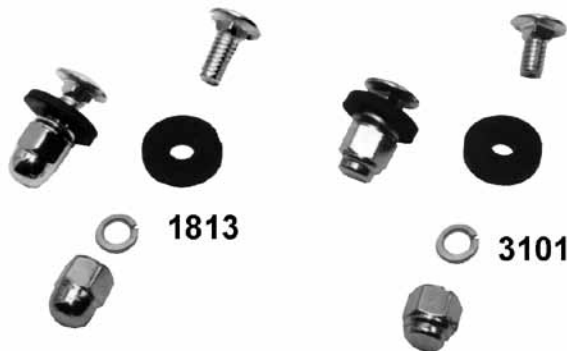

License Plate Mounting Kit

- 1813** Acorn style
- 3101** Cap style
- 9871** Custom flat allens
- 9872** Button allen

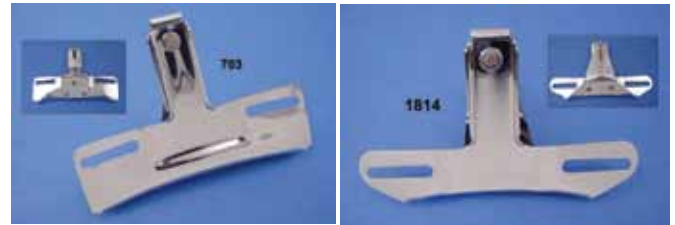

License Plate Bracket

Chrome license plate bracket (mounting above taillight) as used on all Harley Sportster and Big Twin models 1955-up (except FXWG and FXST).

PCP Description

- 1814** Early 2 hole (59992-55A)
- 21710** As above, black finish
- 703** Late 3 hole (59983-75)
- 62020** Red reflector (each) (59988-72)
- 23017** Taillight bracket pad, prevents scratching of rear fender (68456-89) (5 pack)



Chrome License Plate Mounting Bracket Kit

One-piece chromed diecast license plate mount replacing the stamped sheet metal license plate mount and bracket on the rear fender. Rubber spacers cushion the license plate from vibration, and allows the mount to follow the profile of the fender, for a cleaner look. Mounts directly to the stock hole pattern on all HD rear fenders 1955-on (except FXWG and FXST).

- 3325** Complete with hardware



License Plate Reflectors

Reflectors measure 3/4" across the face and a 5/8" long stud with a tension spring and wing nut holds the plate firmly. Classic 50's styling.

- 28201** Blue (4 pack)
- 28202** Amber (4 pack)

License Plate



Chrome License Plate Frames

These chrome diecast license plate frame features embossed eagle with "Live to Ride" (with black background). Mounting holes measure 5-7/8" x 2-3/4" centre-to-centre. The rear of the frame is recessed to accept a license plate of up to approximately 7" x 5". Fits all models (except FXWG and FXST). 7-1/4" x 4-1/4" standard size.

PCP Finish

- | | |
|--------------|---|
| 45129 | Chrome Eagle-Spirit |
| 45229 | Gold Inlay Eagle-Spirit |
| 45115 | Chrome Live to Ride |
| 45215 | Gold Inlay Live to Ride |
| 45151 | Deluxe chrome |
| 45251 | Deluxe gold inlay |
| 45150 | Standard chrome |
| 45152 | Chrome Skull |
| 45156 | Chrome backing plate 7-9/16 W x 4-1/2 H
mounting holes 6-7/8 C/C 2-3/4 C/C |



License Plate Frame With Marker Lights

Chrome frame features built-in vertical amber marker lights. Single filament bulbs can be wired as marker lights or turn signals. 8-7/8 OAW x 4-1/4 high. Holes are 5-3/4 c/c and 2-3/4 c/c.

Recessed for 7-1/4" wide plates.

73002



Skull-Head Krometts - 5 Packs

- | | |
|--------------|--------------------|
| 44002 | Chrome kromett |
| 44005 | Chrome w/ red eyes |
| 44003 | Gold kromett |



Chrome Eagle Spirit Lighted License Frame

Chrome license plate frame includes a built-in red light for an extra measure of safety. Made from chrome plated heavy die-cast metal. The central red light may be wired as an additional brake light or running lamp.

- | | |
|--------------|--------------------------|
| 45182 | Chrome |
| 45183 | Chrome with gold plating |



Chrome "Skull" License Plate Frame

45152



Billet License Plate Frame

Features hidden mount and fits 7-1/4 x 4-1/4" license plate.
21711



Chrome Maltese License Plate Mount Bolt Set

Features 1/4 x 20 Nyloc nuts. 4 Pack.
73693

License Plate



Chrome Lay Down License Plate Bracket

Bracket backside has a faceted shape that allows for counter-sunk mount holes.

59153



Chrome Bracket and Taillight Assembly

Comes complete with taillight, and chrome bracket to fit on stock fenders for FXWG 1980-86 and FXST 1984-on.

Will not fit with OEM luggage rack.

- 57300** Custom assembly
- 59231** Tail lamp only
- 59374** LED lamp only
- 4967** Replacement bulbs (10 pk)



Chrome Layback License Plate Mounting Kit

Kit includes chrome license plate mount and hardware. For use on 3-hole rear fender mount license brackets. Fits 7-1/4" x 4-1/4" plates only.

PCP Application

59154 1999-on FLHR, Road Glide & Electraglide STD (53385-00)



56354

Billet Chrome License Plate & Derby Assembly

License plate assemblies feature a one piece design that includes a round derby cover mount. Available in a 3 or 5 hole design.

PCP	Lamp Style	Hole
56352	Diamond	3
56354	Slice	3



Chrome Billet Fender Mount LED Taillamps

Mount to 3 bolt position on stock fenders. Rubber mounting pad included.

- 59393** Plain
- 59043** Slice
- 59396** Skull
- 59549** Maltese

License Plate

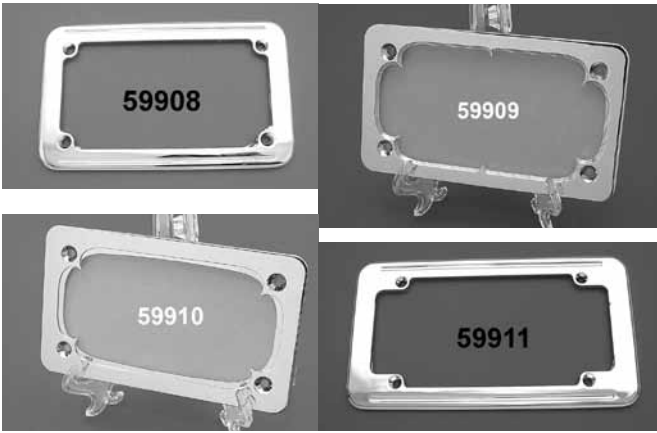

Billet License Plate Frames

Features milled accent designs.

PCP	Pattern (4" x 7")
59908	Slot
59909	Club
59910	Rectangle
PCP	Pattern (4.5" x 8")
59911	Slot



1997-on Lay Down License Plate Bracket

Fits 1997-on Road King models.

59893

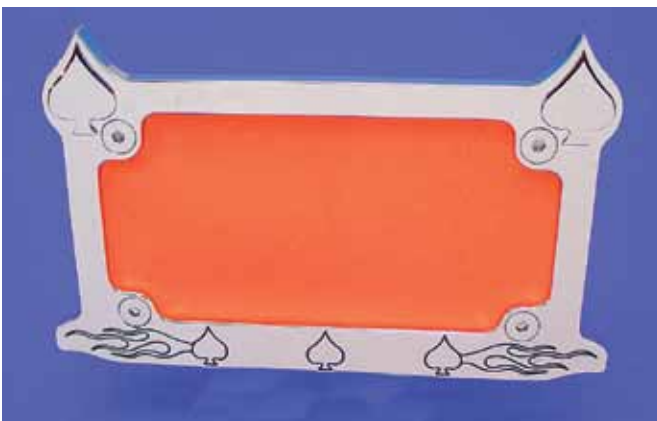

Billet Spade License Plate Mount

Will attach to stock rear fender with 3 bolt holes.

59907



Billet Chrome Taillamp Support Bracket

Features LED. Rail mount for 1997-on FLT models. Note: PCP# 59898 does not have a lamp.

PCP	Style
59898	Spade (no light)



Skull Krommets

PCP	Colour
59545	Amber
59546	Red



T/L LED lighted License Plate Frame

Chrome frame features side LED slot lights that function as auxilliary running and brake lights and a top script running light. Frame is designed for plates measuring 4-1/8" x 7-1/4".

Fits 1989-on XL, 1991-on FXD (except FXDWG), 1986-on Softail (except FXST, FXSTC, FXSTB and FLSTS). FXSTD models require the additional purchase of a wiring adaptor #70316-03. Will not fit with layback license plate mounting kits OEM# 59817-00A or 59822-00. This plate does not provide sufficient plate illumination on other models not listed above.

62031 59030-03

Lenze Trim



Chrome 'Slotted' Turn Signal Trim Rings

These trim rings are made from chrome-plated stamped steel. They fit all OEM and aftermarket turn signals and look really nice when combined with jewelled blue dot lenses and taillight trim rings. Two versions offered, the early and late model flat lenses fitted to the turn signal assemblies on most FL models 1963-on. Sold in pairs.

28421 Late-style. Fits FXRD, FXRT, FLT, FLHT, FLHS and Heritage Softail® 1986-on (shown)



Chrome 'Slotted' Turn Signal Trim Rings

These trim rings are made from chrome-plated stamped steel and fit both OEM and aftermarket turn signals. They look great on plain lenses but look really nice when combined with jewelled blue dot lenses and taillight trim rings. Trim rings are easy to install and are available for most XL, FX and FXR models from 1973-on.

Sold in pairs.

28423 Late-style. Fits all Sportster®, FX and FXR models (except FXRT), FLST, FLSTF and FLSTN Fat Boy® and FXDB Dyna Glide™ models 1986-on

Smoked Turn Signal Lenze Kits

Includes translucent smoked lenze and amber turn signal bulbs which will show amber through lenze. Kits include 4 lenses and 4 amber bulbs.

PCP	Application	Lenze Type
28453	1986-99 FX, 1986-01 XL	Dome (replace flat lenze)
28454	2000-05 Bullet	Dome
28455	1986-on FLST, 2002-05 XL	Flat
28481	Amber bulb set only for above	



Chrome Turn Signal Grill

Louvered, chrome grill installs over the front or rear turn signal lenze on FLT, FLHS, FLHR 1986-on. Sold in pairs.

50027

Turn Signals



Badlands Load Equalizer 3

This solid state, waterproof unit is specially designed for use with Harley-Davidson models equipped with the TSSM Security/Alarm module or the TSM turn signal module. This unit is also compatible with most custom turn signals. This unit allows the use of 4 way flashers for any amount of time and will allow the security system to properly operate. Works with Halogen or LED signals and eliminates erratic blinking of signals.

- 28473** 1988-96 FLH, 1991-95 FXST, 1994-96 Dyna, 1991-98 XL (Badlands)
- 21821** As above, Volt-tech
- 21857** 1997-on FLH, 1996-on FXST, 1997-on Dyna, 1999-03 XL (Badlands)
- 21858** 2004-on XL (Badlands)



Badlands Illuminator

Convert your rear turn signals or marker lights into additional brake lights to increase your visibility. The illuminator maintains turn signal function and has a built-in load equalizer that works with stock or the smallest custom marker lights.

PCP Application

- 28472** 1973-96 All FL, FX, 1973-98 XL and custom wiring
- 28478** 1985-94 FXST, FXR, FXD, 1985-96 FLT, 1986-98 XL
- 28479** 1997-on FXST, FXD, 1997-on FLT, 1999-03 XL
- 28480** 2004-on XL



Badlands Turn Signal Load Equalizer II

This updated unit performs the same functions of the standard unit but also allows for emergency flasher functioning. Fits Big Twin and XL 1991-99 with custom turn signals installed.

- 28471** 1991-99
- *Use Load Equalizer III on 2000-on



Illuminator Pro Model

This module control features automatic cancelling of signals, front running lights, rear running lights, brake light function, and front and rear turn signals on single filament halogen, incandescent or LED bulbs. Includes a built-in load equalizer that runs LEDs up to 70 watts per lamp and an emergency flasher mode that does not build up heat.

28477



Turn Signal Load Equalizer (U.S.A.)

Badlands Motorcycle Products

This electronic unit will correct amperage draw on 1991-on models with self cancelling turn signals allowing the use of custom marker lights. This unit will work on most pre 1991 models also but is necessary on 1991-on. Includes hardware and instructions.

28465



Automatic Turn Signal Shut-Off for 1973-90 Badlands Motorcycle Products (U.S.A.)

This unit allows the turn signals to activate at the touch of a button. Signal will flash for approximately 7 seconds and then automatically shut off; if more signal time is required simply re-touch signal button again.

28105 Kit

Turn Signals



Badlands Plug-In Automatic Signal Canceller

Turn signal cancelling module is available with 3 different plug-in styles to fit most commonly used models. Use this module to replace a broken OEM module or when installing a custom speedo or gas tank. Module can be manually cancelled at any time but, automatically cancels signal after 9 seconds of flashing. Offers a built-in solid state flasher for emergency flasher mode and a built-in load equalizer that runs LED's up to a 100 watts each side. Measures 2-7/8" L x 1-3/8" W x 7/8" D.

PCP Application

28474 10 pin (1987-93 models)

28475 8 pin deutsch (1994-10 models)

28476** 12 pin deutsch (1994-10 models)

**Tech note: Newer factory bikes run the ignition circuit thru the 12 pin security & self cancelling modules. Consult your service manual schematic, to make sure your model does not include this circuit. You can not use this 12 pin module if your security or self cancelling module includes this circuit



Intensifier Hi-Low Modules

Convert single function LED, halogen or incandescent bulbs to dual function.

PCP Application

21859 Single input/single output will run single or multiple driving lights for high & low, single or multiple marker lights for run & stop. Also can use for run&turn on a pair of turn signals if two units are used. Will run up to 50Watts total for driving lights.

21860 Dual inputs/dual output will do run&stop, high&low. Also can use for run&turn for a pair of turn signals with one module. Runs up to 100Watts total for driving lights.



Turn Signal Control Unit

Turn signal self-cancelling control unit replaces stock unit

17225 FXR, Dyna, FXST, XL 1991-93 and FLT 1987-93 (68537-89G)

17226 FLT 1994-95 and XL 1994-96 (68570-94B)

17228 All models 1996-00 (68540-96)

17243 FXD, FLT 2001-06 (68920-01)

17244 FXST 2001-06 (68921-01D)

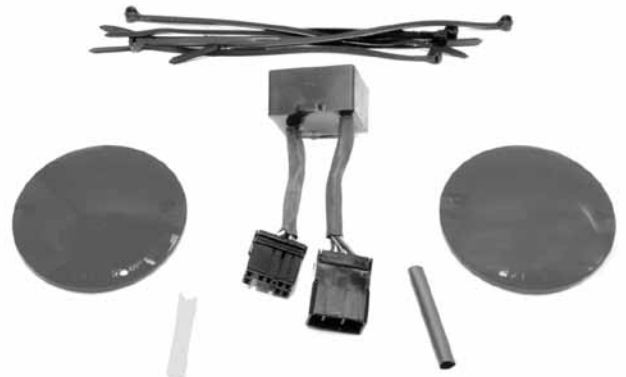

Run Brake Turn Signal Module Kit

Module plugs into existing wiring harness enabling existing turn signals to be used as additional rear brake lighting. Red lenses are included.

66139 Fits Softail 1996-on; Touring 1997-08 (not FLHX), 2009 FLHRC, FLHTC/U with **OEM flat lense** turn signals. (69461-06A)** Does not fit w/directional bar OEM# 68611-68**



Run Brake Turn Signal Module Kit

This module plugs into the existing wiring harness to allow your rear turn signals to function as running and brake lights as well. **Kit includes domed style red lenses.**

66148 XL 2004-on (not 883N or 1200N) (69463-06)

66146 Fits XL 2002-03, FXD 2002-on (not FXDXT or 2009 FXDB), FXST 2002-on (not FXSTD/I, FXDXT) (69462-06A)

66137 FXSTD 2000-07 (not with bags) (69465-06)

Turn Signals



Signal Lights

2 Wire amber signal lights fit 1987-94 FXST and FXR, 1990-94 XL and FLSTF models.

- 28807** Mounts through stanchion
- 28808** Mounts outside stanchion



Late-Style Turn Signal Assemblies 1986-93

These are dual filament front turn signal units for most Harley® models from 1986-93.

- | PCP | Description |
|--------------|--|
| 4986 | Amber lamp unit without threads (68404-86) |
| 4990 | Amber lamp unit with threads (68406-86) |
| 4987 | Amber lens only (68457-86) (each) |
| 56604 | Amber lens with blue dot (each) |
| 4988 | Red lens only (each) |
| 3007 | Chrome trim rings for lens (pair) |



Non-Threaded Turn Signal 1986-on

All units use standard H.D. hardware

- | PCP | Description |
|--------------|-----------------------------|
| 28801 | 1 Wire unit with amber lens |
| 28802 | 1 Wire unit with red lens |
| 28803 | 2 Wire unit with amber lens |
| 28804 | 2 Wire unit with red lens |
| 28004 | Variable load flasher |



Turn Signal Load Equalizer

Equalizer is an electronic unit designed to return amperage draw to the correct factory specifications when marker lights are used to replace stock turn signals on all models with self cancelling system 1991-99. Has 2 yellow wires for lamps and 1 black wire for grounding. Order flasher separately. Not for use with LED lights.

- 59892** 2 Pin



4970



56600

Late Model Turn Signal Lens

Turn signal lenses for 1986-on FXRD, FXRT, FLT, FLHT, FLHS and Heritage Softail® models. Each.

- | PCP | Description |
|--------------|--------------------------|
| 4970 | Amber lens (68440-86) |
| 4971 | Red lens |
| 56600 | Amber lens with blue dot |
| 56601 | Red lens with blue dot |

FLST Turn Signal Relocation

Kit will relocate turn signals from the handlebars to the spot-lamp bracket. Kit includes turn signals for spot lamp, mount bracket and hardware. Fits FLST equipped with #56330 spotlamp kit.

- 28809**

Turn Signals



Late-Style Amber Turn Signals

One and two filament replacement 12 volt turn signals for most FL 1986-on.

PCP	Description
56405	Two filament unit FLT 1986-93 (68400-86)
56406	One filament unit FLT1986-93, FLSTC/N 1986-on (68402-86)
4970	Amber lense (each) (68440-86)
56600	Blue Dot amber lense (each)
4971	Red lense (each)
56601	Blue Dot red lense (each)
4974	Two filament bulb only (68168-89) (10 pack)
4968	One filament bulb only (68572-64B) (10 pack)
28421	Slotted chrome trim rings (pair)

Note: Stock signal units are double filament front and single rear, to use double on rear use bright element only.



Complete Turn Signal Kits

To make it easier for those of you who are builders, we've gathered together all of the turn signal components you'll need under two versions. Both versions include the identical clamps and support hardware necessary to mount the turn signal housings to your handlebars and fender struts. Lamp units are the only difference. One version features late-model (1986-99) housings and amber lenses and dual-filament bulbs for the front and rear, and the other version features early-model (1973-85) housings with amber lenses and single-filament bulbs.

- 6541** Kit with early lamp units and single-filament bulbs 1973-85
- 6540** Kit with late lamp units and dual-filament bulbs 1986-99 FX-FXR-Sportster models. Can also be used to upgrade 1973-85



Late FL Turn Signal Kit 1986-on

Complete 12V turn signal kit with front signal standoffs and 2 extra red lenses.

- 28811** With 2 single and 2 dual wire lights
- 28812** With 4 dual wire lights

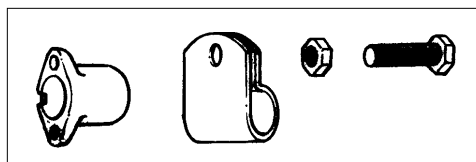

FLH Turn Lamp Mounting Kit

Chrome light mounting kit for 1968-on turn signal lights complete with chrome base, clamp and mounting bolt. Necessary for mounting turn signal below spot lamp unit.

- 1275** Kit (68518-68)
- 44008** Clamps only (pair)
- 44031** Stand-off only (68519-68)

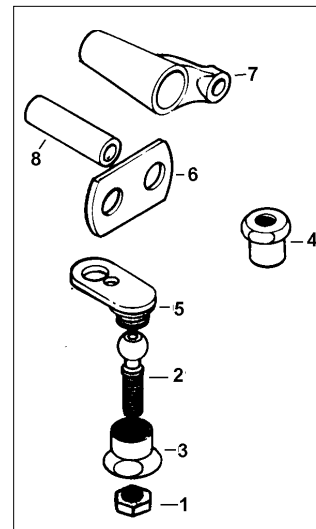

Turn Signal Brackets

Mount signals closer to bike, fit 39mm forks, on 1987-on Sportster and FXR and 1991-95 Dyna, by bolting to top tree using stock hardware. Sold in pairs.

- 28310** Chrome

1988-99 Front Signal Mount Parts

For FXR, Softail, and Sportster Models.

PCP	Item
1	12600 Jam nut (7744) (5 pack)
2	62100 Ball stud (67822-88)
3	62101 Clamp, ball stud (67827-88A)
4	62102 Retainer, right (67828-88A)
5	62103 Ball receptacle, left (67829-88)
6	62104 Bracket (68504-83)
7	62105 Support (chrome) (68555-87)
8	62106 Spacer, front (68559-87)

Turn Signal



Turn Signal Relocation Kit for Softails®

Relocates the rear turn signals further back to allow for saddlebags. Fits FXSTS, FXSTC models 1984-99, and FXWG models 1980-86. Replaces OEM 68548-87A. **17031**



Turn Signal Mounting Hardware

A selection of chrome turn signal mounting components to fit most Harley models from 1973-on.

PCP Description

- 16205** Handlebar clamp with screws (68487-82, 68486-82A)
- 16206** Rear support with screw 1973-93 (68480-73)
- 16250** Rear support only 1994-on (68480-93)
- 16207** Bracket between turn signal lamp and handlebar clamp (68477-73)
- 16208** Stud with spacer (68528-77A)
- 28372** Rear turn signal threaded stud (68493-87) (pairs)
- 28371** As **28372**, 1/2" shorter to move signals closer to bike



Turn Signal Relocation Kit FXR, and XL Models

Allows relocation of the rear turn signals further back to put on saddlebags. Fits XL 1979-89 and FXR 1982-89. **Note:** required for proper turn signal fit when using our #3544 and #3614 saddlebag support kits. **3516** 90504-82A



Turn Signal Relocation Kit

This chrome hardware kit extends rear turn signals further out to allow the installation of saddlebags.

- 17043** Dyna Wide Glide 1993-on
- 17045** XL 1994-03 (68471-94C)



Custom Flat Lens Turn Signal Kit

This custom flat lense turn signal kit features a redesigned socket assembly to accept the new high output GE 921 bulb (included) and a special variable load flasher for a proper flash rate. Fits FX, XL, and FXR models 1973-up. **Note:** when fitted to 1986-up models, this kit will require rewiring to accept single filament turn signal units.

- 28800** Turn signal kit
- 821** Amber lense
- 4943** Red lense w/dot
- 4975** Red lense



LED Bullet Style Turn Signal Kits

PCP	Fits	Lense	LED
28500	Front	Amber	Amber
28501	Rear	Amber	Amber
28508	Front	Clear	Amber
28509	Rear	Clear	Red



Lense Screws

PCP	Application (10 packs)
24520	1973-on Taillight all Twins (68026-73)
24522	1963-85 FL Turn signals (68586-63A)
24523	1973-on FX-XL Signals (68482-73)
24524	1986-on Signal (68452-86)



T/L Signal Light for 1995-on Touring Models
28392 68713-94A

Turn Signals



Front Turn Signal Relocation Kit

Relocate the front turn signals from handlebars to the front forks on Softail Custom and Dyna Wide Glides. Fits 1984-on FXST/B/C, 1993-05 FXDWG and other 41mm front forks.

63028 68952-98



Signal Extensions

Fits XLS-XLH 1990-on. Sold in pairs.

28109



XL Turn Signal Assemblies 1994-on

Amber turn signal units for XL 1994-on

PCP Application

28482	Front 1994-00 (68709-94)
28483	Front 2001-on (68972-00)
28484	Rear 1994-00 (68760-94)
28485	Rear 2001-on (68977-00)



Chrome Turn Signal Bracket Set

Fits 1997-on Road King nacelle models. Mount holes are 6-3/4".

27405

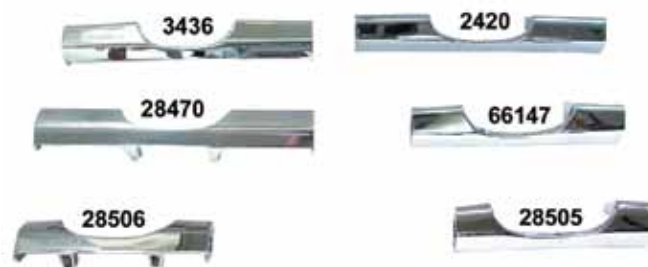

Turn Signal Mounts

These parts stick out the furthest and break first, so we made them stronger. Chrome except where noted.

PCP Fits

2420 1986-on FLST/C, 1993-96 FLSTN (68510-74B) (5-7/8" c/c)

66147* 10" (3" shorter) 1991-08 Touring (not 2004-08 FLHRS and FLTR); 1986-on FLST/C, 1993-96 FLSTN, 2009 FLHRC, FLHTC (not with flat lense turn signal module OEM 91699-99A) (68611-98) (5-7/8" c/c)

28505 8-1/4" (4" Shorter) 1986-on FLST (5-7/8" c/c)

3436 13" 1983-92 FXRD, FXRT, 1985-90 FLH/S/T (68643-83B)

28470 As above, polished

28506 8-1/2" (4" Shorter) 1983-92 FXRD, FXRT, 1985-90 FLH/S/T, 1983-92 FXR (3-11/16 c/c)

*Not w/66139 flat lense turn signal module



Chrome Rear Directional Signal Mount Bars

Formed and welded steel mount bars resist vibration.

28525 1986-on FLST-FSTN-FLSTF, 1991-on Road King (68510-74TB)

28526 As above, 4" shorter

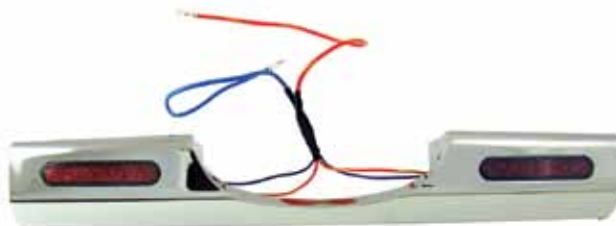

Chrome Light-Up Signal Bar

Chrome plated signal bar features LED lighting for brake and tail light. Fits 1986-on FLSTC, 1991-08 FLT, FLHT, FLHR, FLHS (except FLHRS and FLHX), 1993-96 FLSTN, 1998-03 FLTR and 2009 FLHRC, FLHTC/U. Does not include signal lamps and must be used as auxiliary lighting only.

29117 68143-98A

Turn Signal



28375



28376



28374

Deuce Lenses

PCP	Colour
28374	Amber
28375	Red
28376	Clear



Turn Signal Kit

Chris Products kit includes 4 complete signal lights with amber lenses and dual filament bulbs and 2 studs.

28814

Directional Signal Mounting Kit

Fits XL 883 1988-03, FXR, FXLR 1988-on, FXD/L/X/XT, FXDWG 1991-on, and 1988-on FXST/B/C, FLSTF/S. (left & right side)

28373 68185-00



Turn Signal Kit

Chris Products kit includes 4 complete signal lights with amber lenses and dual filament bulbs. Also includes 2 red lenses.

28815



Chrome Short Rear Turn Signal Mounts

Mounts allow turn signals to be moved in by 1-1/2" on each side. Fits 1984-01 FXST, 1973-85 FX, 1973-01 XL models.

59178 Pair



Deuce Turn Signal Kit

Chris Products kit includes 4 complete signal lights with amber lenses and dual filament bulbs; 2 red lenses and 2 5/8" long studs.

28816



Rear Turn Signal Support

Chris Products support for rear turn signal on Softail models: FXSTI, FXSTFI, FLSTSI, FXSTSI, FXSTBI.

28368 68480-02



FLH Skull Signal Lenses

Amber lenses replace stock style.

56602 Pair

Turn Signal



Front Turn Signal Handlebar Mounting Bracket
Replaces OEM 68476-73 and 68477-73. Fits all 1973-on FX's and XL's with turn signals mounted on handlebars.
3484

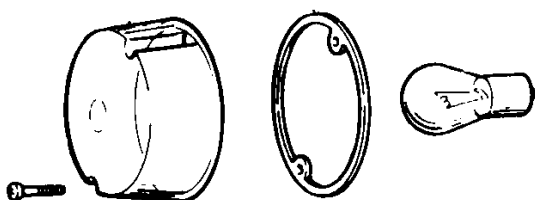

Turn Signal Parts 1973-85

Available in 10 packs

PCP	Item
25183	Gasket (68481-73)
4968	Bulbs (68572-64A)
24523	Screws (68482-73)

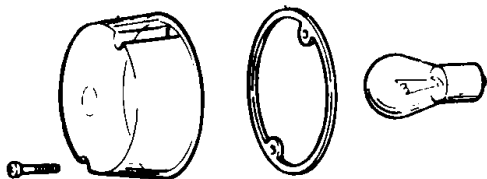

Signal Lense & Screw O-Rings

Sold in 10 in packs for 1986-on.

PCP	Model
14558	Lense O-Ring FL (68451-86)
24524	Screw all (68452-86)
14559	Lens O-Ring FX-XL (68455-86)

Signal Relocation Brackets

Allows front signal lamp to be bolted to mirror stem on 1988-on models. Chrome plated.

62104 68504-83 (each)

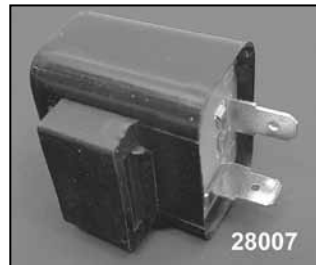

Turn Signal Flashers

PCP Type (68543-64A)

28001	12V Round
28003	12V Rectangle, replica
28007	12V Rectangle, plastic

Hazard Flasher

28004	12V Round (68543-64B)
3999	Mounting clip w/rivet (5 pack)



Toggle Switch

This switch will handle 6 or 12-volts, up to 30 amps. Uses spade terminals and comes with an on/off face plate. It is most commonly used for spotlights on FL models from 1962-84 and FLSTC models from L1987-on.

28102	30 AMP (67844-70, 67858-89)
66402	15 AMP (67844-70, 67858-89)



Chrome Turn Signal Hardware

Replacement hardware for use on late model Dyna and XL.

10814	Threaded rear stud XL 1994-on (56104-94) (each)
17046	Rear support FXDL, FXDWG 1993-on, XL 1994-95 (68480-93)

Turn Signal



Chrome Die-Cast Turn Signal Visors

Chrome-plated turn signal visors. The four mounting bosses are at right angles to each other permitting the installation of the visors to the stock housings in 90° positions. The lens screws are installed through the lens into the housing holding the visor in place.

28302 Fits all FXRD, FXRT, FLT, FLHT, FLHS and Heritage Softail® models 1986-on.



Chrome Turn Signal Trim Rings

Chrome plated stamped steel and easy to fit on both the OEM and aftermarket turn signals.

PCP Description (pairs)

3006 Early-style. Fits all XL, FX and FXR models (except FXRT) front and rear turn signals 1973-85 (67741-90T)

3007 Late-style. Fits all XL, FX, FXR (except FXRT), Dyna FLST, FLSTF FLSTN and Dyna Glide models 1986-on (67739-90T)

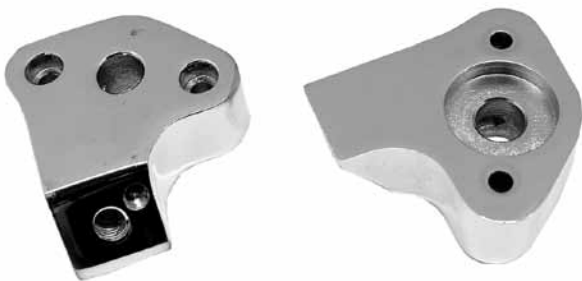

Shortie Chrome R/turn Signal Mount Brackets

Aluminum brackets that bring the signals closer to the fender for a cleaner look. Fits 1986-92 FLST and 1985-92 FLHT & FLHS models.

28315 Brackets with no hardware



Bullet Light Mounting Kit

This kit allows quick and easy installation of our custom bullet marker lights on most rear fender struts and Big Twins/XLs to 1987 with 35mm Narrow Glides front forks. Includes 4 chrome plated mounting blocks and the necessary hardware to install the bullet lights.

3860 14 piece mounting kit (marker light not included)

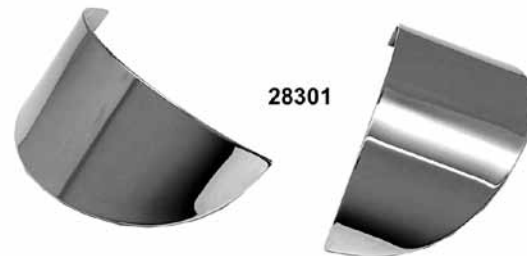

Late-Model Turn Signal Visors

We offer two versions of turn signal visors which will fit late-style front or rear housings on most "full Dresser" and Heritage Softail® models 1986-on. Complete with mounting hardware where necessary. Sold in pairs.

PCP Description

28300 Fits the front of all FLHT/C, FLHS and FLSTC models 1986-on (67734-88T)

28301 Fit the front of 1988-on FLTCs and the rear of all FLTC, FLHT/C, FLHS, FLST/C, FXRD and FXRT models 1986-on (67737-88T)



Chrome Turn Signal Mount Set

Allows signals to be located under control boxes on bars for XL models. Replaces 68266-03.

59899

Turn Signal



Chrome Rear Turn Signal Bar

Fits 1999-08 Touring models (not FLHX), 2009 FLHRC, FLHTC, FLST/C 1999-08. Not compatible with OEM Heritage classic bags.

64315 68615-04



64313



Front Turn Signal Mounting Kit

Allows mounting of stock front turn signal on FXST, FXD, FLSTF, FLSTS and XL.

64316 68266-03



64314

Bullet Style Turn Signal Kit

Includes housing, lenses, and supports.

64313 2000-01 Softail, 1991-01 Dyna, 1990-01 XL (68005-99)

64314 1988-99 Softail, except FLSTC (68007-99)



LED Bullet Signal Set with Textured Lenses

PCP	LED	Mount Type
28828	Amber	41mm clamp
28829	Amber	Swivel mount
28830	Red	FL mount
28831	Amber	Stand-off mount
28832	Amber	Headlight mount
28833	Red	Short stud
28834	Amber	39mm clamp
28835	Red	Long stud
28836	Amber	49mm clamp



Chrome Turn Signal Relocation Kit

Will move turn signals from the handbar to the lower triple tree. Includes chrome mount posts, wiring, and hardware. 1988-* XL, 1991-05 Dyna (not FXDWG)

62030 68517-94A

Turn Signal



Amber Torpedo FXSTD Bullet Signal Light

Sold each.

- 28161 Bullet lamp
- 28162 LED Bullet lamp
- 28163 Turn signal with stem

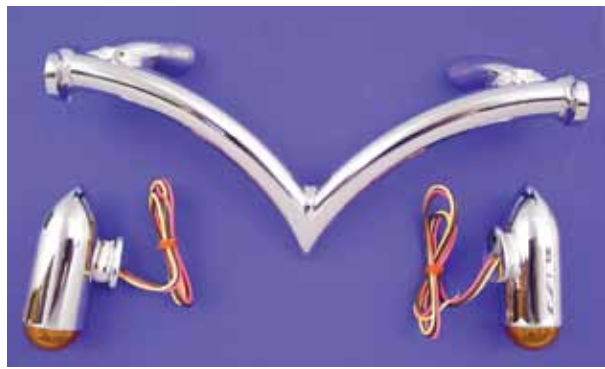

V-Shape Rear Turn Signal Kit

Fits FLST, FXST, FLH, FLT. Includes red/amber LED bulb lamps.

- 28166 Kit
- 28167 LED Lamp set



Torpedo Lamp Set (Clear)

Measures 4x2-5/16" body with 12 volt Halogen , 35 watt bulb.
28289



Mini Speeder Bullet Lamp Set

Includes red lenses.

- 28291 Single
- 28411 Dual



Krommet-Light Studs

12 volt mini lamps with Krommet base to attach license plates and accessories. Sold in set of 4.

- 73581 Amber
- 73582 Red
- 73583 Blue



FLT Chrome Turn Signal Assembly

Includes lense and 12 volt bulb.

- 28164 1994-on front amber, single contact
- 28165 1994-on front amber, dual contact



- 28168 OEM type amber LED turn signal set for FLT, FLST



Eagle Eye Lamp Set

Features amber lense and billet extension stem.

PCP	Lens Length	End-to-End
28290	1-3/4"	3-1/2"
28412	3"	4-1/2"

2" Chrome Skull Marker Lamp

These lamps have illuminated eyes and for decoration only.

- 73537 Bulb
- 28182 LED



Turn Signal



Chrome Round Turn Signal Bars

Includes hollow bolts to mount custom turn signals.

PCP Application
28208 1991-04 FLT



28293

Chrome Low Boyz Turn Signal Bar

Threaded to accept stock turn signals and mounts to license plate bracket holes. Replaces 68430-89.

PCP Application
28293 12" Bar kit
73677 End nut (68424-89) (each)



28368



Rear Signal Mounts

PCP Application
28369 FXSTD (68821-00)
28368 FXST (68480-02)
28383 FXR (68493-92)
28109 XL rear extended



Chrome Front Signal Relocation Mount

Fits 1988-on FXSTS models with factory spring fork. These chrome brackets move the signals to the spring bracket behind the springs. Order light separately.

17107



Chrome Signal LED Light (Pair)

PCP Lens LED
28435 Amber Clear
28436 Clear Red



17266



17267



Chrome Signal LED Light with Mount (Pair)

PCP Lens LED
28437 Clear Amber

Front Turn Signal Mount Kit

Bolts to billet headlamp lower mount.

PCP Length
17266 8.5"
17267 5.5"

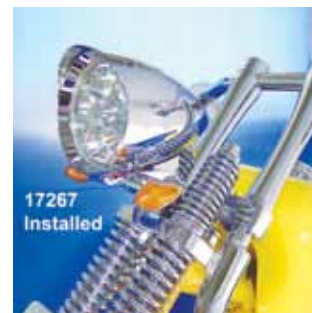

17267
 Installed

Marker Lights

Note: These lights may be insufficient for good visibility. Recommended only for additional lighting to the OEM lights.



Flush Mount Marker Lights

These chrome-plated marker lights feature swept back styling and die-cast construction. They're available in red or amber and have single filament bulbs. They measure approximately 3½" long x 1¼" wide. Sold in pairs.

56407 Red (1 wire) wedge

56408 Amber (1 wire) wedge

28326 Bulbs (10 pack)



Chrome Marker Light Bracket

Chrome, diecast brackets allow for custom mounting of marker lights or turn signals. Use in place of stock front fork cover side trim on Heritage and Fat Boy models 1986-on.

27247



Dual Auxiliary Light Mount

A universal chrome mounting bar that mounts on all rear license plate brackets.

4579



Mini Diamond Light

A miniature marker light with a diamond shape. This 12 volt, 4 watt light features a one-piece, die-cast construction with an integrated pedestal base all chrome plated. The lens measures 1-1/4" high x 1-7/8" wide. (single filament bulb) Sold in pairs

4696 Amber Diamond light (1 wire)

50018 Red replacement lense (ea)

50019 Amber replacement lense (ea)



Die Cast Tour Lights

12V available in mini or standard size. Standard measures 2-1/8H x 2-3/8W x 2-1/4D. Mini measures 1-1/ wire exists through mount bolt for clean design. Amber or red. Sold Each.

Standard measures 2-1/8H x 2-3/8W x 2-1/4D.

PCP	Lense (1 Wire)	PCP (2 Wire)	Bulbs
3130	Amber	56414	Amber 4964
3131	Red	56415	Red 4964

Mini measures 1-1/8H x 1-3/4W

PCP	Lense(1 Wire)	Bulbs
4808	Amber (1 wire)	4965
4809	Red (1 wire)	4965
56583	Red lense	



LED Centre Mount Marker Lights

PCP	Colour (Pairs)
59900	Amber
59901	Green
59902	Blue
59903	Orange
59904	Purple
59905	Red
59906	Clear



Amber Clearance Lights

These lights will fit into the end of 1" handlebars (as wires run through bars some fitting is required, also grip rubber ends must be opened up). Amber lense will face forward and backwards, ball shaped with a chrome body. Single wire but could be used as a signal light. Sold in pairs.

51100

Marker Lights



Handlebar Mounted Mini Marker Lights

These rectangular lights with concave back mount flush to any 1" handlebar hiding the wiring inside. Drilling required.

28343 Dual bulb lights (pair)

28327 Replacement dual bulb (10 pack)



Front Fork Clamp-on Mini Marker Light Kits

Hidden wire, 2 piece clamp-on construction allows for simple, clean installation on BT and XL front forks.

Single Bulb Kit

28336 Fits 39mm fork

28326 Replacement single bulb (10 pack)

Dual Bulb Kit

28337 Fits 39mm fork, dual bulb kit

28339 Fits 41mm fork, dual bulb kit

28327 Replacement dual bulb (10 pack)

17048 39mm smooth front fork clamps (pair)

17105 As above ribbed (pair)

17049 41mm smooth front fork clamps (pair)

17257 Fits 35mm fork (pairs)



Diamond Marker Lights

Stylish diamond shaped lights feature an angled "billet" look and through-the-bolt wiring, providing clean installation. Each light comes with a 12 volt single filament bulb and red lense. Sold each.

28304

Grooved Billet Fork Clamps

PCP Size

17106 41mm

17105 39mm



Billet Chopper Pegs with Built-in LED Lamp

PCP Colour

59223 Amber

59224 Red



Ribbed Fork Mount Turn Marker Lamp Set

Chrome lamp has a die-cast, two piece housing with a 12V bulb. Attaches to 35, 39 and 41mm fork tubes. Not DOT approved.

PCP Type Filament

28332 Front panel Single

28326 Replacement single bulb (10 pack)

28330 Side panel Dual

28327 Replacement dual bulb (10 pack)

Marker Lights



Snake Eye Lights

These Deco chrome lights are 1.75"x2.25" long, with 1/4" stud mount. Sold in pairs.

- 28169** Amber
- 28170** Red
- 56581** Amber lense (each)
- 28326** Bulbs (10 pack)



Chrome Mini 12 Volt Bullet Lamp Sets

Available in LED type. Measures 1"W x 3"L x 1-1/2"H. Sold in pairs.

- 28176** Amber 2 wire
- 28177** Blue 3 wire
- 28178** Red 2 wire
- 28179** Clear 1 wire



Chrome Maltese Cross Marker Lamps

Measures 2.5" square design with red LED.

28171



Chrome Bullet Lamp Set- Single Filament

Includes LED units, body measures 2-1/4" OD x 3-3/4" long.

28180



LED Mini Bullet Lamps

These lamps are 12 volt and 2.5" long. Sold in pairs.

- 28172** Amber
- 28173** LED Amber

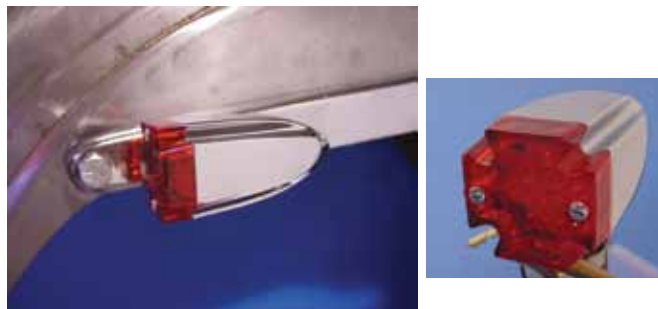

Maltese Cross Bullet Lamps

Features LED bulb. Sold in pairs.

- 28181** Amber
- 28184** Red



Clear Bulb Lamp Set

Red LED bulbs. Sold in pairs.

28175

Marker Lights



Bullet Light

Chris Products bullet light features a double filament bulb with amber lense. Front Duece style turn signal replaces 68885-00 and 68972-00.

28365



Bullet Light

Chris Products bullet light features a double filament bulb with amber lense. This light is wired through mounting hole and can be mounted with studs listed below.

28367

Mounting Studs

PCP	Body Length
28370	5/8" (pair)
28371	1-1/4" (pair)
28372	1-7/8" (pair)



Chrome Marker Light

These lights measure 2-1/4" in diameter by 3-3/4" long. They include a 12V, 20 watt halogen bulb and a clear. Sold in pairs.

59045



Rear Bullet Light

Chris Products bullet light features a double filament bulb with amber lense. Rear Duece style turn signal replaces 68977-00.

28366



Baby Bullet Light

Chrome light with glass lense measures 1-1/8" diameter x 2-1/4" from tip to top with a 5/16-18 x 1" long mounting stud. Sold in pairs.

59103	Red
59104	Amber
28416	Blue



Chrome Mini Bullet Lamp Sets

Lamps measure 1"W x 3"L x 1-1/2"H.

PCP	Colour
28361	Amber
28362	Blue
28363	Red
28364	Clear



Bullet Light- Single Filament

These chrome bullet lights feature a built-in 360 degree turn-able visor with a clear and an extra lense. Pairs.

59046	Grooved (blue)
59047	Smooth (yellow)
17258	Bulb set

Marker Lights



LED Diamond Marker Lamp Sets

Feature coloured lenses with LED bulbs.

PCP **Lense Colour**

28408 Blue



Mini-Marker Lamp Sets

Features an amber LED bulb with a clear lense.

PCP **Style**

28399 Cat eye

28405 Maltese



Flush Mount Marker Lamp Sets

PCP **Length**

28410 3.5"



Mini Cat-eye Winker Lamp Set

28415



12 Volt Shielded Chrome Bullet Lamp Set

PCP **Colour**

28413 Amber

28414 Red



Chrome Billet "G" Clamps

Will hold wiring or line. Has a 7/16" screw and is sold in a 5 pack.

PCP **Clamp** **Tube Size**

73684 1/4" 1-1/16"

73688 7/16" 1-1/2"



Mini-Square Marker Lamp Set

12 volt set with chrome body.

28174

Marker Lights



Lazer LED Bulbs

Features coloured LEDs with clear band for license plate.

PCP	Application	Type
28393	1965-02 Tail-brake	Red 1157
28394	1965-on Signal	Amber 1156
28395	2003-on Tail-brake	Red 3157

12 Volt LED Micro Lamp Set

PCP	Colour	Lense Colour
28396	Amber	Amber
28397	Red	Clear
28398	Amber	Clear



Rear Turn Signal Kit

Fits FLST, FXST, FLH, FLT. Includes red/amber LED bulb lamps.

28167 LED lamp kit



Hyper Lamp Set

Features 4 choices for lens colour, amber, red, smoke and clear. 8 Lenses in total.

28318



Tour Light Clamps (lights not included)

Non slip two-piece positive mount rail clamp. Available to fit any 1/2" & 5/8" diameter tube rails. Light wires can be inconspicuously routed through clamps mounting bolt. These clamps fit PCPI #3130 & #3131 Tour lights.

3132



Turn Signal Lamp Kits

Fits 1994-on FLHT and 1996-on FLST.

PCP	Bulb	Lense
28185	Clear	Amber (69063-03)

Marker Lights



Note: These lights may be insufficient for good visibility. Recommended only for additional lighting to the OEM lights.



Custom Bullet Marker Lights

With Visor

- 815** Red light (single filament bulb)
- 3179** Amber light (single filament bulb)
- 4965** Bulbs (10 pack)
- 3222** Red light (dual filament bulb)
- 3221** Amber light (dual filament bulb)
- 4964** Bulb (10 pack)

"Bomber Light"

Diecast Bullet style light with 3 fins, and visor built-in. Truly deluxe amber lense. Order different coloured lenses separately. (single filament bulbs)

- 4950** Red
- 4951** Amber

Replacement Bulb

- 4964** Dual filament (box of 10)
- 4965** Single filament (box of 10)

Styler Marker Lamps

Die cast & chrome plated. Styler Lamp I is 2 3/4" long and 1-1/8" deep. Red lamps have 3/8" mount holes for strut mounting. Amber have 5/16" holes for front fork mounting. Styler Lamp II flush mounts to fender struts or flat surfaces. Sold in pairs.

PCP	Description	Filament
28322	Amber I	1
28323	Amber I	2
28324	Red II	1
28325	Amber II	1
28326	Bulb (10 Pack)	1
28327	Bulb (10 Pack)	2

Bullet Light Visors

For 1-3/4" lights

- 438** 10 pack

Bullet Light Lens Only

Available in different colours, these lenses will fit either standard bullet light or super Marker light.

Bullet Light Lens

Plastic

- PCP** Colour
- 816** Amber (each)
- 817** Blue (each)
- 818** Red (each)



Bullet Lite with Stem-12V

Can be utilized as signal, or as brake-signal with dual filament. Red lense.

- 4952** Single filament
- 4965** Bulb
- 4953** Double filament
- 4964** Bulb

Bullet Lights with Mounting Brackets (1 Wire)

- 4979** Red light with right mount (68567-50)
- 4980** Red light with left mount (68566-50)
- 28316** Amber light with right side mount
- 28317** Amber light with left side mount
- 4965** Single filament bulbs (box of 10)
- 816** Amber lense
- 817** Blue lense
- 818** Red lense

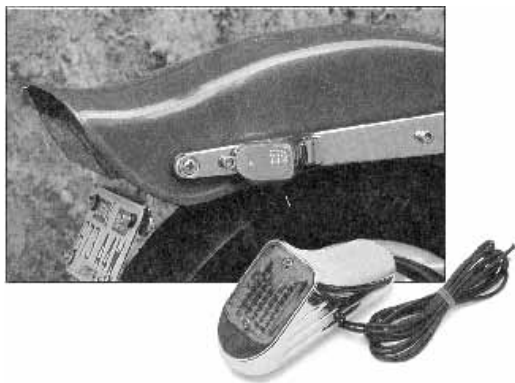

Chrome Shoe Marker Lights

12 Volt marker lights mount to fender struts and include the necessary hardware. Not DOT certified. Sold as a set of 2.

- PCP** Description
- 28346** Amber lense
- 28347** Red lense